



RESULTS BOOK

KARATE WORLD CHAMPIONSHIPS - INDIVIDUAL
WORLD CHAMPIONSHIPS - CAIRO 2025

2025.11.27 - 2025.11.30

3894+XV8, AL ESTAD, QESM THAN MADINET NASR, CAIRO
GOVERNORATE 4436020

EGYPT, EGY

TABLE OF CONTENTS

NUMBER OF ENTRIES	4
NUMBER OF ENTRIES BY CONTINENT	6
ENTRYLIST	10
STATISTICS	20
FEMALE KATA	21
FEMALE KUMITE -50 KG	34
FEMALE KUMITE -55 KG	47
FEMALE KUMITE -61 KG	60
FEMALE KUMITE -68 KG	73
FEMALE KUMITE 68+ KG	86
MALE KATA	99
MALE KUMITE -60 KG	112
MALE KUMITE -67 KG	125
MALE KUMITE -75 KG	138
MALE KUMITE -84 KG	151
MALE KUMITE 84+ KG	164
OFFICIAL RESULTS	178
MEDAL STANDING	181

NUMBER OF ENTRIES



Karate World Championships - Individual World Cha ..

EGYPT

2025.11.27 - 2025.11.30

3894+XV8, Al Estad, Qesm Than Madinet Nasr, Cairo Governorate 4436020



NUMBER OF ENTRIES

#	Code	National Federation	Male Entries	Female Entries	Total Entries	Total Athletes
1		ALB ALBANIA	2	0	2	2
2		ALG ALGERIA	5	6	11	11
3		ANG ANGOLA	2	1	3	3
4		ARG ARGENTINA	2	0	2	2
5		ARM ARMENIA	2	0	2	2
6		ARU ARUBA	1	0	1	1
7		AUS AUSTRALIA	6	6	12	12
8		AUT AUSTRIA	0	3	3	3
9		AZE AZERBAIJAN	4	2	6	6
10		BEL BELGIUM	2	4	6	6
11		BEN BENIN	1	0	1	1
12		BIH BOSNIA AND HERZEGOVINA	1	1	2	2
13		BRA BRAZIL	3	3	6	6
14		BUL BULGARIA	0	2	2	2
15		BUR BURKINA FASO	1	1	2	2
16		BDI BURUNDI	1	1	2	2
17		CMR CAMEROON	0	2	2	2
18		CAN CANADA	1	3	4	4
19		CHI CHILE	5	4	9	9
20		TPE CHINESE TAIPEI	4	1	5	5
21		COL COLOMBIA	3	3	6	6
22		CRO CROATIA	2	3	5	5
23		CZE CZECH REPUBLIC	1	1	2	2
24		DOM DOMINICAN REPUBLIC	2	2	4	4
25		ECU ECUADOR	2	2	4	4
26		EGY EGYPT	6	6	12	12
27		ESA EL SALVADOR	0	2	2	2
28		ENG ENGLAND	1	1	2	2
29		FRA FRANCE	5	5	10	10
30		GEO GEORGIA	2	2	4	4
31		GER GERMANY	2	6	8	8
32		GRE GREECE	5	4	9	9
33		GUA GUATEMALA	3	2	5	5
34		GUI GUINEA	0	1	1	1
35		HKG HONG KONG, CHINA	2	3	5	5
36		HUN HUNGARY	1	1	2	2
37		IND INDIA	2	3	5	5
38		IRI ISLAMIC REPUBLIC OF IRAN	5	5	10	10
39		ITA ITALY	6	6	12	12
40		JPN JAPAN	6	6	12	12
41		JOR JORDAN	4	1	5	5
42		KAZ KAZAKHSTAN	4	4	8	8
43		KOS KOSOVO	2	1	3	3
44		KUW KUWAIT	2	0	2	2
45		KGZ KYRGYZSTAN	1	0	1	1
46		LAT LATVIA	0	2	2	2



Karate World Championships - Individual World Cha ..

EGYPT

2025.11.27 - 2025.11.30

3894+XV8, Al Estad, Qesm Than Madinet Nasr, Cairo Governorate 4436020



NUMBER OF ENTRIES

#	Code	National Federation	Male Entries	Female Entries	Total Entries	Total Athletes
47		LBA LIBYA	2	0	2	2
48		LUX LUXEMBOURG	1	1	2	2
49		MAS MALAYSIA	0	3	3	3
50		MEX MEXICO	1	3	4	4
51		MDA MOLDOVA, REPUBLIC OF	1	0	1	1
52		MNE MONTENEGRO	4	0	4	4
53		MAR MOROCCO	5	3	8	8
54		NEP NEPAL	0	2	2	2
55		NED NETHERLANDS	2	3	5	5
56		NZL NEW ZEALAND	3	3	6	6
57		NGR NIGERIA	1	4	5	5
58		MKD NORTH MACEDONIA	1	1	2	2
59		CHN PEOPLES REPUBLIC OF CHINA	1	3	4	4
60		PHI PHILIPPINES	0	1	1	1
61		POL POLAND	1	2	3	3
62		POR PORTUGAL	3	3	6	6
63		PUR PUERTO RICO	0	1	1	1
64		KOR REPUBLIC OF KOREA	1	0	1	1
65		ROU ROMANIA	2	2	4	4
66		RWA RWANDA	1	0	1	1
67		KSA SAUDI ARABIA	4	1	5	5
68		SCO SCOTLAND	0	1	1	1
69		SEN SENEGAL	2	0	2	2
70		SRB SERBIA	3	0	3	3
71		SGP SINGAPORE	0	1	1	1
72		SVK SLOVAKIA	2	4	6	6
73		SLO SLOVENIA	1	0	1	1
74		RSA SOUTH AFRICA	2	2	4	4
75		ESP SPAIN	2	4	6	6
76		SWE SWEDEN	1	4	5	5
77		SUI SWITZERLAND	1	3	4	4
78		THA THAILAND	1	0	1	1
79		TUN TUNISIA	3	2	5	5
80		TUR TURKIYE	5	4	9	9
81		UKR UKRAINE	4	5	9	9
82		USA UNITED STATES	4	2	6	6
83		UZB UZBEKISTAN	4	4	8	8
84		VEN VENEZUELA	2	2	4	4
85	WKF	WKF-1 WKF-1	5	1	6	6
86	WKF	WKF-2 WKF-2	2	1	3	3
Totals:			190	188	378	378



NUMBER OF ENTRIES BY NATIONAL FEDERATION AND CONTINENT



Karate World Championships - Individual World Championships - Cairo
2025

As of 2 DEC 2025

Code	Continent / National Federation	Male Entries	Female Entries	Total Entries	Total Athletes
	AFRICA				
ALG	ALGERIA	5	6	11	11
ANG	ANGOLA	2	1	3	3
BEN	BENIN	1	0	1	1
BUR	BURKINA FASO	1	1	2	2
BDI	BURUNDI	1	1	2	2
CMR	CAMEROON	0	2	2	2
EGY	EGYPT	6	6	12	12
GUI	GUINEA	0	1	1	1
LBA	LIBYA	2	0	2	2
MAR	MOROCCO	5	3	8	8
NGR	NIGERIA	1	4	5	5
RWA	RWANDA	1	0	1	1
SEN	SENEGAL	2	0	2	2
RSA	SOUTH AFRICA	2	2	4	4
TUN	TUNISIA	3	2	5	5
Total	AFRICA	15	32	61	61
	ASIA				
TPE	CHINESE TAIPEI	4	1	5	5
HKG	HONG KONG, CHINA	2	3	5	5
IND	INDIA	2	3	5	5
IRI	ISLAMIC REPUBLIC OF IRAN	5	5	10	10
JPN	JAPAN	6	6	12	12
JOR	JORDAN	4	1	5	5
KAZ	KAZAKHSTAN	4	4	8	8
KUW	KUWAIT	2	0	2	2
KGZ	KYRGYZSTAN	1	0	1	1
MAS	MALAYSIA	0	3	3	3
NEP	NEPAL	0	2	2	2
CHN	PEOPLES REPUBLIC OF CHINA	1	3	4	4
PHI	PHILIPPINES	0	1	1	1
KOR	REPUBLIC OF KOREA	1	0	1	1
KSA	SAUDI ARABIA	4	1	5	5
SGP	SINGAPORE	0	1	1	1
THA	THAILAND	1	0	1	1
UZB	UZBEKISTAN	4	4	8	8
Total	ASIA	18	41	79	79
	EUROPE				



NUMBER OF ENTRIES BY NATIONAL FEDERATION AND CONTINENT



Karate World Championships - Individual World Championships - Cairo
2025

As of 2 DEC 2025

Code	Continent / National Federation	Male Entries	Female Entries	Total Entries	Total Athletes
ALB	ALBANIA	2	0	2	2
ARM	ARMENIA	2	0	2	2
AUT	AUSTRIA	0	3	3	3
AZE	AZERBAIJAN	4	2	6	6
BEL	BELGIUM	2	4	6	6
BIH	BOSNIA AND HERZEGOVINA	1	1	2	2
BUL	BULGARIA	0	2	2	2
CRO	CROATIA	2	3	5	5
CZE	CZECH REPUBLIC	1	1	2	2
ENG	ENGLAND	1	1	2	2
FRA	FRANCE	5	5	10	10
GEO	GEORGIA	2	2	4	4
GER	GERMANY	2	6	8	8
GRE	GREECE	5	4	9	9
HUN	HUNGARY	1	1	2	2
ITA	ITALY	6	6	12	12
KOS	KOSOVO	2	1	3	3
LAT	LATVIA	0	2	2	2
LUX	LUXEMBOURG	1	1	2	2
MDA	MOLDOVA, REPUBLIC OF	1	0	1	1
MNE	MONTENEGRO	4	0	4	4
NED	NETHERLANDS	2	3	5	5
MKD	NORTH MACEDONIA	1	1	2	2
POL	POLAND	1	2	3	3
POR	PORTUGAL	3	3	6	6
ROU	ROMANIA	2	2	4	4
SCO	SCOTLAND	0	1	1	1
SRB	SERBIA	3	0	3	3
SVK	SLOVAKIA	2	4	6	6
SLO	SLOVENIA	1	0	1	1
ESP	SPAIN	2	4	6	6
SWE	SWEDEN	1	4	5	5
SUI	SWITZERLAND	1	3	4	4
TUR	TURKIYE	5	4	9	9
UKR	UKRAINE	4	5	9	9
Total	EUROPE	35	72	153	153
	OCEANIA				
AUS	AUSTRALIA	6	6	12	12
NZL	NEW ZEALAND	3	3	6	6



NUMBER OF ENTRIES BY NATIONAL FEDERATION AND CONTINENT



Karate World Championships - Individual World Championships - Cairo
2025

As of 2 DEC 2025

Code	Continent / National Federation	Male Entries	Female Entries	Total Entries	Total Athletes
Total	OCEANIA	2	9	9	18
	PAN AMERICA				
ARG	ARGENTINA	2	0	2	2
ARU	ARUBA	1	0	1	1
BRA	BRAZIL	3	3	6	6
CAN	CANADA	1	3	4	4
CHI	CHILE	5	4	9	9
COL	COLOMBIA	3	3	6	6
DOM	DOMINICAN REPUBLIC	2	2	4	4
ECU	ECUADOR	2	2	4	4
ESA	EL SALVADOR	0	2	2	2
GUA	GUATEMALA	3	2	5	5
MEX	MEXICO	1	3	4	4
PUR	PUERTO RICO	0	1	1	1
USA	UNITED STATES	4	2	6	6
VEN	VENEZUELA	2	2	4	4
Total	PAN AMERICA	14	29	58	58
WKF-1	WKF-1	5	1	6	6
WKF-2	WKF-2	2	1	3	3
Total		2	7	9	9
Total		86	190	378	378

RESULTS BOOK



ENTRYLIST



Karate World Championships - Individual World Cha ..



ENTRIES BY NATIONAL FEDERATION

As of 2 DEC 2025

Code	ID	Gender	Name	Event	Seeding
ALB	ALB2002	M	ARIFI ORGES	Male Kumite -60 Kg	5
	ALB02650	M	MELOS GASHI	Male Kumite -84 Kg	5
ALG	ALG2163	M	DAIKHI HOCINE	Male Kumite 84+ Kg	5
	ALG02552	M	HELASSA AYOUB ANIS	Male Kumite -67 Kg	5
	ALG04850	M	MIDOUNE FALLEH	Male Kumite -84 Kg	6
	ALG04187	M	ZAID OUSSAMA	Male Kumite -75 Kg	5
	ALG03041	M	ZIAD YUCEF	Male Kata	5
	ALG02679	F	ABOURICHE LOUIZA	Female Kumite -55 Kg	5
	ALG11679	F	DAHLEB NARIMENE	Female Kata	5
	ALG10418	F	GHELAM KHADIDJA	Female Kumite -61 Kg	5
	ALG02881	F	MEKKAOUI KARIMA	Female Kumite -68 Kg	5
	ALG2482	F	OUDIRA CHAIMA	Female Kumite 68+ Kg	5
	ALG02678	F	OUIKENE CYLIA	Female Kumite -50 Kg	1
ANG	ANG02023	M	LOPES NARIO	Male Kumite -75 Kg	6
	ANG002067	M	MAYALA LEONARDO	Male Kumite -84 Kg	7
	ANG002061	F	FRANCOIS ELISA	Female Kumite -50 Kg	5
ARG	ARG02552	M	GALLARDO JUAN IGNACIO	Male Kumite -60 Kg	6
	ARG2093	M	IMPAGNATIELLO LUCA MATEO	Male Kata	6
ARM	ARM2142	M	HARUTYUNYAN SUREN	Male Kumite -75 Kg	7
	ARM2223	M	NERSISYAN GOR	Male Kumite -84 Kg	8
ARU	ARU002084	M	TIMMERMANS ROB	Male Kumite 84+ Kg	6
AUS	AUS2322	M	ATTRIDGE RORY	Male Kumite -67 Kg	6
	AUS290	M	DURHAM MITCHELL	Male Kumite -75 Kg	8
	AUS02705	M	FISHER DYLAN	Male Kata	7
	AUS2089	M	FREUND JONATHAN	Male Kumite -84 Kg	9
	AUS257	M	GEORGIEFF ANGEL	Male Kumite 84+ Kg	7
	AUS2375	M	SQUIRE DECLAN	Male Kumite -60 Kg	7
	AUS02700	F	BOYCE KRYSTAL	Female Kumite 68+ Kg	6
	AUS2172	F	DIMOVSKA STEPHANIE	Female Kata	6
	AUS003077	F	GOLDING LAURA	Female Kumite -68 Kg	6
	AUS2209	F	LAWRENCE GEORGIE	Female Kumite -55 Kg	6
	AUS02729	F	TRAN CECILIA	Female Kumite -50 Kg	6
	AUS02484	F	WEBB IRIS	Female Kumite -61 Kg	6
AUT	AUT2234	F	DEVIGILI HANNA	Female Kumite -68 Kg	7
	AUT2066	F	TOPALOVIC LEJLA	Female Kumite -61 Kg	7
	AUT2015	F	ZILLER LORA	Female Kumite 68+ Kg	7
AZE	AZE201	M	GURBANLI ASIMAN	Male Kumite 84+ Kg	8
	AZE211	M	HASANOV TURGUT	Male Kumite -84 Kg	10
	AZE275	M	HEYDAROV ROMAN	Male Kata	8
	AZE02341	M	RZAZADE NURAN	Male Kumite -67 Kg	7
	AZE2201	F	SADIGOVA MADINA	Female Kumite -55 Kg	7
	AZE2043	F	ZARETSKA IRYNA	Female Kumite -68 Kg	1
BEL	BEL2201	M	ABDELMALKI ANASS	Male Kumite -60 Kg	8
	BEL2033	M	MAHAUDEN QUENTIN	Male Kumite -75 Kg	9

Report Created: 2 DEC 2025

1 / 9



Karate World Championships - Individual World Cha ..



ENTRIES BY NATIONAL FEDERATION

As of 2 DEC 2025

Code	ID	Gender	Name	Event	Seeding
BEL	BEL02934	F	AJARAY MARYAM	Female Kumite -61 Kg	8
	BEL02518	F	EL AIDI AYAH	Female Kumite -55 Kg	8
	BEL02370	F	MANCA CHIARA	Female Kata	7
	BEL2219	F	MULOLO OPHELIE	Female Kumite 68+ Kg	8
BEN	BEN02086	M	KPADONOU MARTIAL	Male Kumite -60 Kg	9
BIH	BIH2179	M	BOSTANDZIC ANES	Male Kumite 84+ Kg	4
	BIH2110	F	SIPOVIC EMINA	Female Kumite -61 Kg	9
BRA	BRA2716	M	ALBERTO FILIPE	Male Kumite -84 Kg	11
	BRA2069	M	FELIPIN SALGADO GIOVANI	Male Kumite 84+ Kg	9
	BRA299	M	FIGUEIRA VINICIUS	Male Kumite -67 Kg	4
	BRA03318	F	HENRIQUE GABRIELLE	Female Kata	8
	BRA2044	F	PEREIRA BRENDA	Female Kumite 68+ Kg	9
	BRA2042	F	RODRIGUES BARBARA	Female Kumite -61 Kg	3
BUL	BUL304	F	GORANOVA IVET	Female Kumite -55 Kg	9
	BUL2210	F	TSANEVA TEODORA	Female Kumite -50 Kg	7
BUR	BUR02123	M	KABORE MOHAMED	Male Kumite -60 Kg	10
	BUR2036	F	ROMBA ANICHA	Female Kata	9
BDI	BDI002289	M	MUKESHIMANA BRILLANT	Male Kata	9
	BDI02087	F	ISHIMWE SIFA ALICE	Female Kumite -55 Kg	10
CMR	CMR02391	F	NELLY DZEU YOUNBI	Female Kumite -61 Kg	10
	CMR02581	F	OLIVIA DAVINA BODIONG GABOAYA	Female Kumite -68 Kg	8
CAN	CAN02732	M	EBRAHEEM KARIM	Male Kumite -67 Kg	8
	CAN245	F	FURUMOTO-DESHAIES HANA	Female Kumite -55 Kg	11
	CAN2249	F	LAHYANSSA YAMINA	Female Kumite -50 Kg	8
	CAN2109	F	LAOS-LOO CLAUDIA	Female Kata	10
CHI	CHI2097	M	FREIRE FUENTES TOMAS	Male Kumite -67 Kg	9
	CHI2116	M	HUAIQUIMAN FABIAN	Male Kumite -84 Kg	12
	CHI2033	M	QUIJADA PELAYO MATIAS	Male Kumite -60 Kg	11
	CHI2036	M	RODRIGUEZ FUENTES MATIAS	Male Kumite -75 Kg	10
	CHI139	M	ROJAS RODRIGO	Male Kumite 84+ Kg	10
	CHI129	F	GONZALEZ LAVIN JAVIERA	Female Kumite 68+ Kg	10
	CHI2361	F	HUAIQUIMAN BARBARA	Female Kumite -61 Kg	11
	CHI2015	F	TORO MENESES VALENTINA	Female Kumite -55 Kg	2
	CHI03118	F	VELOZO ANASTASIIA	Female Kumite -68 Kg	9
TPE	TPE174	M	CHEN CHAO-CHING	Male Kata	10
	TPE02734	M	HSU LI-WEI	Male Kumite -60 Kg	12
	TPE2232	M	PAN CHE-EN	Male Kumite -84 Kg	13
	TPE2046	M	SHIH CHENG-CHUNG	Male Kumite -67 Kg	10
	TPE159	F	KU TSUI-PING	Female Kumite -55 Kg	12
COL	COL02565	M	FORERO JUAN	Male Kumite -60 Kg	13
	COL168	M	HENAO AMU RUBEN DARIO	Male Kumite -84 Kg	14
	COL2007	M	RAMIREZ ALEJANDRO	Male Kata	11
	COL2040	F	BERNAL HERRERA NATALIA	Female Kumite -61 Kg	12



Karate World Championships - Individual World Cha ..



ENTRIES BY NATIONAL FEDERATION

As of 2 DEC 2025

Code	ID	Gender	Name	Event	Seeding	
COL	COL2195	F	CARDENAS BALCAZAR SOFIA	Female Kumite -50 Kg	9	
	COL2228	F	ZAPATA MACHADO VALENTINA	Female Kata	11	
CRO	CRO367	M	KVESIC ANDJELO	Male Kumite 84+ Kg	3	
	CRO399	M	KVESIC IVAN	Male Kumite -84 Kg	15	
	CRO2104	F	BECIROVIC SADEA	Female Kumite -68 Kg	10	
	CRO2457	F	GOLOMBOS NIKOLINA	Female Kumite 68+ Kg	11	
	CRO2209	F	SGARDELLI EMA	Female Kumite -50 Kg	3	
CZE	CZE2153	M	BOSAK ONDREJ	Male Kumite 84+ Kg	11	
	CZE213	F	MISKOVA VERONIKA	Female Kata	12	
DOM	DOM131	M	CASTILLO ANEL	Male Kumite 84+ Kg	12	
	DOM2119	M	DE CASTRO HERIBERTO	Male Kata	12	
	DOM2022	F	RODRIGUEZ OGANDO PAMELA	Female Kumite 68+ Kg	12	
	DOM2006	F	TERRERO ALCANTARA THALIA	Female Kumite -55 Kg	13	
ECU	ECU02313	M	ACEVEDO JOSE ANTONIO	Male Kumite -84 Kg	16	
	ECU02356	M	VALLEJO CESAR ANTONIO	Male Kumite 84+ Kg	13	
	ECU2099	F	ALVARADO LILI	Female Kumite -50 Kg	10	
	ECU128	F	FACTOS JACQUELINE	Female Kumite -61 Kg	13	
EGY	EGY2218	M	ABDELAZIZ ABDALLA MAMDUH	Male Kumite -75 Kg	1	
	EGY2208	M	ALY ZYAD ELGHARIB	Male Kumite -60 Kg	4	
	EGY2625	M	BADAWY YOUSSEF	Male Kumite -84 Kg	2	
	EGY2534	M	ELGHOBASHY MOSTAFA	Male Kata	13	
	EGY319	M	ELSAWY ALI	Male Kumite -67 Kg	11	
	EGY2205	M	MAHMOUD TAHA TAREK	Male Kumite 84+ Kg	1	
	EGY2627	F	ALY NOURSIN	Female Kumite -61 Kg	14	
	EGY2194	F	HENDY HADIR	Female Kumite -68 Kg	11	
	EGY387	F	HESHAM AYA	Female Kata	13	
	EGY2525	F	OKILA MENNA SHAABAN	Female Kumite 68+ Kg	13	
	EGY2528	F	SALAMA REEM AHMED	Female Kumite -50 Kg	11	
	EGY2630	F	YOUSSEF AHLAM	Female Kumite -55 Kg	3	
	ESA	ESA2056	F	IZAGUIRRE GABRIELLA	Female Kumite -50 Kg	12
		ESA02134	F	IZAGUIRRE GALDAMEZ ESTEFANY RACHEL	Female Kumite -55 Kg	14
ENG	ENG02926	M	PATRICK ASHTON	Male Kumite -84 Kg	17	
	ENG2406	F	WALTERS ROCHELLE	Female Kumite 68+ Kg	14	
FRA	FRA2231	M	BERTHON ENZO	Male Kumite -75 Kg	3	
	FRA2668	M	CONFIAC HENDRICK	Male Kumite -84 Kg	18	
	FRA2077	M	FILALI MEHDI	Male Kumite 84+ Kg	14	
	FRA04085	M	KLEMZ THOMAS	Male Kata	14	
	FRA2370	M	SALMI YOUNESSE	Male Kumite -67 Kg	12	
	FRA2249	F	BONNARDE TIPHAINE	Female Kumite -50 Kg	13	
	FRA372	F	GARCIA NANCY	Female Kumite 68+ Kg	15	
	FRA02723	F	SOMBE THALYA	Female Kumite -68 Kg	4	
	FRA02938	F	TAILY HELVETIA	Female Kata	14	
	FRA02778	F	YVON SYDNEY	Female Kumite -61 Kg	15	



Karate World Championships - Individual World Cha ..



ENTRIES BY NATIONAL FEDERATION

As of 2 DEC 2025

Code	ID	Gender	Name	Event	Seeding
GEO	GEO02419	M	GELASHVILI MERABI	Male Kumite 84+ Kg	15
	GEO02600	M	SORDIA TSOTNE	Male Kumite -60 Kg	14
	GEO02669	F	VASADZE MARIAMI	Female Kumite -50 Kg	14
	GEO2149	F	ZVIADAURI LIZI	Female Kumite -55 Kg	15
GER	GER2584	M	OEZDEMIR MUHAMMED	Male Kumite -67 Kg	13
	GER2092	M	TELLOCKE MORRIS	Male Kata	15
	GER2519	F	BITSCH MIA	Female Kumite -55 Kg	4
	GER289	F	BLEUL JASMIN	Female Kata	15
	GER2252	F	HUBRICH SHARA	Female Kumite -50 Kg	15
	GER03113	F	KHAMIS REEM	Female Kumite -61 Kg	16
	GER2090	F	KNEER JOHANNA	Female Kumite 68+ Kg	3
	GER02746	F	RIEDEL HANNAH	Female Kumite -68 Kg	12
GRE	GRE02321	M	BALLOTIS GEORGIOS	Male Kumite -67 Kg	14
	GRE487	M	MASTROGIANNIS KONSTANTINOS	Male Kumite -84 Kg	4
	GRE774	M	NIKOPOULOS ATHANASIOS	Male Kumite 84+ Kg	16
	GRE521	M	XENOS CHRISTOS-STEFANOS	Male Kumite -60 Kg	2
	GRE004060	M	ZYGOURIS KONSTANTINOS	Male Kumite -75 Kg	11
	GRE565	F	KYDONAKI KYRIAKI	Female Kumite 68+ Kg	4
	GRE02642	F	PAPPA CHRISTINA TRIADA	Female Kumite -50 Kg	16
	GRE2076	F	STOLI MARIA	Female Kumite -55 Kg	16
	GRE308	F	XENOU GEORGIA-ARCHONTIA	Female Kata	16
GUA	GUA2005	M	CHACON CARLOS JOSE	Male Kumite -67 Kg	15
	GUA2029	M	DE LA ROCA PEDROPABLO	Male Kumite -60 Kg	15
	GUA115	M	RAMIREZ GONZALEZ BRANDON LIZANDRO	Male Kumite -84 Kg	19
	GUA02145	F	CEVASCO BARRIENTOS FABIANA	Female Kumite -55 Kg	17
	GUA2027	F	PALENCIA LUISA	Female Kumite -68 Kg	13
GUI	GUI002591	F	KEITA ANNE-CORALIE TYPHAINE	Female Kumite -68 Kg	
HKG	HKG2139	M	CHENG HUI PAN	Male Kumite -67 Kg	16
	HKG162	M	HUNG HO WAI HOWARD	Male Kata	16
	HKG177	F	LAU MO SHEUNG GRACE	Female Kata	1
	HKG191	F	TSANG YEE TING	Female Kumite -50 Kg	17
	HKG2148	F	WONG CHEUK LEE	Female Kumite -68 Kg	14
HUN	HUN258	M	HARSPATAKI KAROLY GABOR	Male Kumite -75 Kg	12
	HUN02677	F	FLEISCHER DORA	Female Kumite 68+ Kg	16
IND	IND2746	M	MAHARA BOOSHANAM AKSHAY	Male Kumite -84 Kg	20
	IND2207	M	SEHRAWAT SUDHIR	Male Kumite 84+ Kg	17
	IND03857	F	ALI HANEE	Female Kumite -61 Kg	17
	IND03639	F	ALISHA ALISHA	Female Kumite -55 Kg	18
	IND03020	F	JADHAV BHUVANESHWARI SURESH	Female Kumite -68 Kg	15
IRI	IRI2024	M	ABAZARI SALEH	Male Kumite 84+ Kg	18
	IRI03111	M	BORZOOEICHAGHAGOLANI AMIRREZA	Male Kumite -67 Kg	17
	IRI2164	M	KHODABAKHSHI MAHDI	Male Kumite -84 Kg	21
	IRI2143	M	MESKINI ALI	Male Kumite -60 Kg	16



Karate World Championships - Individual World Cha ..



ENTRIES BY NATIONAL FEDERATION

As of 2 DEC 2025

Code	ID	Gender	Name	Event	Seeding	
IRI	IRI2346	M	NEMATI MORTEZA	Male Kumite -75 Kg	13	
	IRI2134	F	BAHMANYAR SARA	Female Kumite -50 Kg	4	
	IRI02709	F	GOLSHADNEZHAD ATOUSA	Female Kumite -61 Kg	4	
	IRI2132	F	HEYDARIOZOMCHELOE MOBINA	Female Kumite -68 Kg	16	
	IRI2481	F	SAADATI FATEME	Female Kumite -55 Kg	19	
	IRI287	F	SADEGHI DASTAK FATEMEH	Female Kata	17	
	ITA	ITA02948	M	AVANZINI MATTEO	Male Kumite 84+ Kg	2
ITA266		M	CRESCENZO ANGELO	Male Kumite -60 Kg	17	
ITA2510		M	DE VIVO DANIELE	Male Kumite -75 Kg	14	
ITA2507		M	GHINAMI ALESSIO	Male Kata	3	
ITA329		M	MARESCA LUCA	Male Kumite -67 Kg	18	
ITA494		M	MARTINA MICHELE	Male Kumite -84 Kg	22	
ITA308		F	D ONOFRIO TERRYANA	Female Kata	3	
ITA570		F	FERRACUTI CLIO	Female Kumite 68+ Kg	17	
ITA03155		F	GRAZIOSI AURORA	Female Kumite -61 Kg	18	
ITA395		F	LALLO VIOLA	Female Kumite -55 Kg	20	
ITA376		F	PERFETTO ERMINIA	Female Kumite -50 Kg	2	
ITA377		F	SEMERARO SILVIA	Female Kumite -68 Kg	17	
JPN		JPN03258	M	HASHIMOTO HIROMU	Male Kumite -60 Kg	1
	JPN2077	M	KOZAKI YUGO	Male Kumite -67 Kg	2	
	JPN2470	M	NISHIYAMA KAKERU	Male Kata	1	
	JPN2313	M	SAKIYAMA YUSEI	Male Kumite -75 Kg	15	
	JPN2314	M	SHIMADA RIKITO	Male Kumite -84 Kg	23	
	JPN02706	M	YOSHIMURA FUMIYA	Male Kumite 84+ Kg	19	
	JPN03040	F	KAMA TSUBASA	Female Kumite -68 Kg	3	
	JPN02782	F	KODO RINA	Female Kumite -55 Kg	21	
	JPN02704	F	OKAZAKI AIKA	Female Kumite -50 Kg	18	
	JPN2451	F	ONO MAHO	Female Kata	2	
	JPN02840	F	SHIMADA SARARA	Female Kumite -61 Kg	19	
	JPN03367	F	SUGITA SUMIRE	Female Kumite 68+ Kg	18	
	JOR	JOR02338	M	AL NAJJAR SAEED	Male Kumite -75 Kg	16
		JOR2281	M	ALJAFARI MOHAMMAD	Male Kumite -84 Kg	1
		JOR2159	M	GHAITH AFEEF	Male Kumite -67 Kg	19
JOR2141		M	HAMMAD ABDALLAH	Male Kumite -60 Kg	18	
JOR02537		F	NASER YARA	Female Kumite 68+ Kg	19	
KAZ		KAZ2006	M	ALPYSBAY KAISAR	Male Kumite -60 Kg	19
	KAZ215	M	AMIRALI DIDAR	Male Kumite -67 Kg	20	
	KAZ2028	M	AZHIKANOV NURKANAT	Male Kumite -75 Kg	2	
	KAZ02741	M	ULBEK DIAS	Male Kumite 84+ Kg	20	
	KAZ2140	F	BERULTSEVA SOFYA	Female Kumite 68+ Kg	2	
	KAZ02709	F	DARENSKAYA DAIYANA	Female Kumite -68 Kg	18	
	KAZ2198	F	KANAY ASSEL	Female Kumite -61 Kg	1	
	KAZ2033	F	USSENOVA GULMIRA	Female Kumite -55 Kg	22	
KOS	KOS2378	M	MALIQI BETIM	Male Kumite -75 Kg	17	
	KOS2347	M	SELMANI ISLAM	Male Kumite -60 Kg	20	
	KOS2382	F	QERIMI VLERA	Female Kumite -68 Kg	19	

Report Created: 2 DEC 2025

5 / 9



Karate World Championships - Individual World Cha ..



ENTRIES BY NATIONAL FEDERATION

As of 2 DEC 2025

Code	ID	Gender	Name	Event	Seeding
KUW	KUW186	M	ALMOSAWI SAYED SALMAN	Male Kata	17
	KUW188	M	SHAABAN ABDULLAH	Male Kumite -60 Kg	21
KGZ	KGZ002616	M	KALYKOV BEKZHAN	Male Kumite -60 Kg	22
LAT	LAT02561	F	GIRVICA BEATA	Female Kumite -61 Kg	20
	LAT2073	F	MIHAILOVA ALEKSANDRA	Female Kumite -50 Kg	19
LBA	LBA02105	M	ABDULSALAM NURI	Male Kumite 84+ Kg	21
	LBA02377	M	ABUDABOUS MOHAMED	Male Kumite -75 Kg	18
LUX	LUX02279	M	DAVIES ALEXANDER	Male Kumite 84+ Kg	22
	LUX124	F	WARLING JENNIFER	Female Kumite -55 Kg	23
MAS	MAS02710	F	ADNAN ZAKIAH	Female Kumite -61 Kg	21
	MAS02418	F	CHANDRAN SHAHMALARANI	Female Kumite -50 Kg	20
	MAS02384	F	LOVELLY ANNE ROBBERTH	Female Kata	18
MEX	MEX294	M	VILLARREAL AVILA CARLOS JULIAN	Male Kumite -75 Kg	19
	MEX274	F	QUINTAL CATZIN GUADALUPE	Female Kumite 68+ Kg	20
	MEX2350	F	QUIROZ CASTILLO YANETH	Female Kata	19
	MEX2030	F	SALCIDO KATIA	Female Kumite -50 Kg	21
MDA	MDA02267	M	CAPMOALE ALEXANDR	Male Kumite -67 Kg	21
MNE	MNE342	M	DULOVIC NENAD	Male Kumite -67 Kg	22
	MNE244	M	MIJAC VLADIMIR	Male Kata	18
	MNE2045	M	MIKULIC NEMANJA	Male Kumite -75 Kg	20
	MNE2277	M	VOJINOVIC Balsa	Male Kumite -60 Kg	23
MAR	MAR2258	M	HANNI REDA	Male Kumite 84+ Kg	23
	MAR03097	M	LAMOUM TIJANI	Male Kata	19
	MAR2271	M	OUBAYA SAID	Male Kumite -67 Kg	1
	MAR003566	M	SAM HAMZA	Male Kumite -75 Kg	21
	MAR2275	M	SRITI MEHDI	Male Kumite -84 Kg	24
	MAR2238	F	BROUK NISRINE	Female Kumite -68 Kg	20
	MAR02527	F	ELHAYTI CHAIMAE	Female Kumite -55 Kg	24
	MAR2034	F	EN-NESYRY AYA	Female Kata	20
NEP	NEP003158	F	GURUNG ARIKA	Female Kumite 68+ Kg	21
	NEP003280	F	THING SANU MAYA	Female Kata	21
NED	NED02684	M	FRANKEN RICARDO	Male Kumite -75 Kg	22
	NED2028	M	TIMMERMANS BRIAN	Male Kumite -84 Kg	25
	NED221	F	CREEMERS INGRID	Female Kumite 68+ Kg	22
	NED02396	F	KAKIAY ASHLEY	Female Kumite -61 Kg	22
	NED2016	F	SNEL LYNN	Female Kumite -68 Kg	21
NZL	NZL195	M	ROWSBY NICHOLAS	Male Kata	20
	NZL2087	M	SOMERVILLE LOGAN	Male Kumite -75 Kg	23
	NZL02439	M	TAKEUCHI REO	Male Kumite -67 Kg	23
	NZL2000	F	ALDRIDGE BRITNEY	Female Kumite -55 Kg	25
	NZL2113	F	MCLACHLAN JULIET	Female Kumite -68 Kg	22
	NZL184	F	WIGG HOLLY	Female Kata	22



Karate World Championships - Individual World Cha ..



ENTRIES BY NATIONAL FEDERATION

As of 2 DEC 2025

Code	ID	Gender	Name	Event	Seeding
NGR	NGR02147	M	OLORUNMBE OLUWASEUN	Male Kata	21
	NGR02405	F	ABODE CONSTANCE TAMUNODIEPREYE	Female Kumite -61 Kg	23
	NGR2030	F	NWANKWO UJUNWA CAROLINE	Female Kumite 68+ Kg	23
	NGR2029	F	OKORO LOVETH NGOZI	Female Kumite -50 Kg	22
	NGR2105	F	UKOHA-SAMPSON GODFIRST ORIE	Female Kumite -55 Kg	26
MKD	MKD533	M	VESELI FAHIK	Male Kumite -60 Kg	24
	MKD369	F	MOJSOVSKA ANGELA	Female Kumite -68 Kg	23
CHN	CHN02572	M	YANG KANGWEI	Male Kata	22
	CHN2139	F	GONG LI	Female Kumite -61 Kg	24
	CHN2455	F	TAO YIWEI	Female Kata	23
	CHN02840	F	WEI YUCHUN	Female Kumite -55 Kg	27
PHI	PHI02129	F	ALFORTE SAKURA	Female Kata	24
POL	POL2485	M	DZIUDA DOMINIK	Male Kumite -67 Kg	24
	POL4033	F	DANISZEWSKA JULIA	Female Kumite 68+ Kg	24
	POL06896	F	LEWANDOWSKA KATARZYNA	Female Kumite -61 Kg	25
POR	POR2177	M	DUARTE TIAGO	Male Kumite -75 Kg	24
	POR2170	M	MENDES JOAQUIM	Male Kumite -67 Kg	25
	POR02545	M	NETO ARTUR	Male Kata	23
	POR228	F	CRUZ ANA	Female Kata	25
	POR251	F	OLIVEIRA ANA RITA	Female Kumite 68+ Kg	25
	POR2187	F	RODRIGUES CATARINA	Female Kumite -50 Kg	23
PUR	PUR2007	F	FONSECA ROMERO JANESSA MICHELLE	Female Kumite -68 Kg	24
KOR	KOR02163	M	HWANG TAEYEON	Male Kata	24
ROU	ROU2480	M	COMANESCU PETRU	Male Kata	25
	ROU2183	M	TORNACI ERHAN	Male Kumite -60 Kg	25
	ROU2185	F	COMAN MARIA CRISTINA	Female Kumite 68+ Kg	26
	ROU254	F	MALAUTA MIRUNA MIHAELA	Female Kumite -61 Kg	26
RWA	RWA2062	M	NTWARI FISTON	Male Kumite -67 Kg	26
KSA	KSA2058	M	ALASSIRI MOHAMMED	Male Kumite -67 Kg	27
	KSA153	M	ALBASHER SAUD	Male Kumite -60 Kg	26
	KSA2191	M	ALZHRANI SULTAN	Male Kumite -75 Kg	25
	KSA2265	M	SUFYANI SANAD	Male Kumite 84+ Kg	24
	KSA03183	F	ALRASHED NORAH	Female Kumite -50 Kg	24
SCO	SCO2098	F	JUNNER NIAMH	Female Kumite 68+ Kg	27
SEN	SEN02471	M	DIOP MAKHTAR	Male Kumite -84 Kg	26
	SEN02432	M	DIOP MOUHAMADOU FALILOU	Male Kumite 84+ Kg	25
SRB	SRB2045	M	BREZANCIC VLADIMIR	Male Kumite -84 Kg	27
	SRB191	M	JOKSIC STEFAN	Male Kumite -67 Kg	28
	SRB526	M	TESANOVIC DJORDE	Male Kumite 84+ Kg	26
SGP	SGP02154	F	LEONG WAI YEE SHANNON	Female Kata	26



Karate World Championships - Individual World Cha ..



ENTRIES BY NATIONAL FEDERATION

As of 2 DEC 2025

Code	ID	Gender	Name	Event	Seeding
SVK	SVK2199	M	HRCKA ROMAN	Male Kata	26
	SVK02501	M	SECKAR SIMON	Male Kumite -84 Kg	28
	SVK03126	F	FIALKOVA SOFIA	Female Kata	27
	SVK2193	F	KRIVDOVA SARA	Female Kumite -68 Kg	25
	SVK02345	F	KVASNICOVA NINA	Female Kumite -55 Kg	28
	SVK2293	F	VARGOVA NATALIA	Female Kumite -50 Kg	25
SLO	SLO2458	M	SLUGA JURE	Male Kata	27
RSA	RSA003638	M	DHLAMINI BRESHNEV	Male Kumite 84+ Kg	27
	RSA2068	M	WILLIAMS JODY	Male Kumite -67 Kg	29
	RSA02619	F	LUFF CARLA	Female Kumite -68 Kg	26
	RSA2262	F	ROETZ MARINDA	Female Kumite -50 Kg	26
ESP	ESP02607	M	GUTIERREZ MARQUES BORJA	Male Kumite 84+ Kg	28
	ESP173	M	QUINTERO CAPDEVILA DAMIAN HUGO	Male Kata	28
	ESP03582	F	BENTAMA-SERROUKH JEBARI INSAF	Female Kumite -50 Kg	27
	ESP02672	F	GARCIA LOZANO PAOLA	Female Kata	28
	ESP2359	F	NIETO MEJIAS MARIA ISABEL	Female Kumite -68 Kg	27
	ESP2007	F	TORRES GARCIA MARIA	Female Kumite 68+ Kg	1
SWE	SWE02584	M	VU ANTHONY	Male Kata	29
	SWE02480	F	BAO BEDNARSKI SOPHIE	Female Kumite 68+ Kg	28
	SWE185	F	KARLSSON MIA	Female Kata	29
	SWE201	F	NILSSON ANNA-JOHANNA	Female Kumite -61 Kg	27
	SWE2151	F	ROSENLIND MATILDA	Female Kumite -55 Kg	29
SUI	SUI2121	M	UJIHARA YUKI	Male Kata	30
	SUI202	F	QUIRICI ELENA	Female Kumite -68 Kg	2
	SUI2015	F	RADJENOVIC NINA	Female Kumite -61 Kg	28
	SUI267	F	SCHAERER MAYA	Female Kumite -50 Kg	28
THA	THA2221	M	MUEKTHONG SIWAKON	Male Kumite -60 Kg	27
TUN	TUN02620	M	AYAT MOHAMED	Male Kumite -60 Kg	28
	TUN02634	M	GHAZOUANI RAYEN	Male Kumite -84 Kg	29
	TUN02328	M	TLILI AHMED RAYANE	Male Kumite -75 Kg	26
	TUN02580	F	BEN TAIEB ISRA	Female Kumite 68+ Kg	29
	TUN02329	F	MAHJOUB Wafa	Female Kumite -61 Kg	29
TUR	TUR2211	M	ARSLAN HASAN	Male Kumite -84 Kg	30
	TUR2430	M	OZDEMIR ENES	Male Kata	4
	TUR2050	M	OZER OMER ABDURRAHIM	Male Kumite -67 Kg	3
	TUR632	M	SAMDAN ERAY	Male Kumite -60 Kg	3
	TUR2674	M	YURUR OMER FARUK	Male Kumite -75 Kg	4
	TUR713	F	BOZAN DILARA	Female Kata	30
	TUR786	F	ELTEMUR EDA	Female Kumite -68 Kg	28
	TUR308	F	HOCAGLU AKYOL MELTEM	Female Kumite 68+ Kg	30
	TUR2604	F	YENEN FATMA NAZ	Female Kumite -61 Kg	30
	UKR	UKR274	M	CHOBOTAR VALERII	Male Kumite -84 Kg



Karate World Championships - Individual World Cha ..



ENTRIES BY NATIONAL FEDERATION

As of 2 DEC 2025

Code	ID	Gender	Name	Event	Seeding
UKR	UKR2283	M	FILIPOV NIKITA	Male Kumite -60 Kg	29
	UKR2020	M	TALIBOV RYZVAN	Male Kumite 84+ Kg	29
	UKR2204	M	ZAPLITNYI ANDRII	Male Kumite -75 Kg	27
	UKR02864	F	BULAY DARIIA	Female Kumite 68+ Kg	31
	UKR2269	F	PALASHEVSKA YULIIA	Female Kumite -50 Kg	29
	UKR2280	F	SHOLOHOVA OLEKSANDRA	Female Kumite -61 Kg	2
	UKR2373	F	SIELIEMIENIEVA ELINA	Female Kumite -68 Kg	29
	UKR240	F	TERLIUGA ANZHELIKA	Female Kumite -55 Kg	1
USA	USA02564	M	AKDE EVANGELOS	Male Kumite -67 Kg	30
	USA03000	M	SAGILYAN EDUARD	Male Kumite 84+ Kg	30
	USA173	M	SCOTT THOMAS	Male Kumite -75 Kg	28
	USA283	M	TORRES GUTIERREZ ARIEL	Male Kata	2
	USA196	F	KOKUMAI SAKURA	Female Kata	4
	USA2328	F	LINGL SKYLAR	Female Kumite -68 Kg	30
UZB	UZB2157	M	MUKHAMMADIYEV KUVONCHBEK	Male Kumite -75 Kg	29
	UZB02461	M	NAMOV SHUXRATJON	Male Kumite -84 Kg	32
	UZB02714	M	RASHIDOV ABDUL VAKHKHOB	Male Kumite -67 Kg	31
	UZB02713	M	TURAKHONOV MEKHRIDDIN	Male Kumite -60 Kg	30
	UZB02597	F	ALIMARDANOVA GULSHAN	Female Kumite -50 Kg	30
	UZB02442	F	KHAKIMJONOVA MOKHLAROYIM	Female Kumite 68+ Kg	32
	UZB02811	F	OTABOYEVA SEVINCH	Female Kumite -61 Kg	31
	UZB2293	F	RAKHIMOVA SEVINCH	Female Kumite -55 Kg	30
VEN	VEN192	M	CASANOVA GUERRERO CLEIVER	Male Kata	31
	VEN003431	M	CHATAING JHOISBER	Male Kumite -60 Kg	31
	VEN02559	F	OLIGINO DIANA	Female Kata	31
	VEN297	F	SALAZAR CAMACHO YORGELIS	Female Kumite -50 Kg	31
WKF-1	RUS2881	M	AKHMEDOV AKHMED	Male Kumite -60 Kg	32
	RUS03178	M	GASPARIAN EDUARD	Male Kumite -84 Kg	3
	RUS03179	M	GOLOVIN MAKAR	Male Kumite 84+ Kg	31
	RUS2340	M	OGANNISIAN IURIK	Male Kumite -67 Kg	32
	RUS2433	M	SHARAFUTDINOV ERNEST	Male Kumite -75 Kg	30
	RUS2306	F	CHERNYSHEVA ANNA	Female Kumite -55 Kg	31
WKF-2	AIN-200277 8	M	KUDZINAU IVAN	Male Kumite 84+ Kg	32
	BLR2090	M	NHUYEN DEVID	Male Kumite -75 Kg	31
	BLR2087	F	AZARAVA MARYIA	Female Kumite -61 Kg	32

RESULTS BOOK



STATISTICS



Karate World Championships - Individual World Cha ..



Statistics

Participating Countries: 86

	Competitors	Entries
Female	188	188
Male	190	190
Total	378	378

Entries per Category	Entries	Teams
Female Kata	31	-
Female Kumite -50 Kg	31	-
Female Kumite -55 Kg	31	-
Female Kumite -61 Kg	32	-
Female Kumite -68 Kg	31	-
Female Kumite 68+ Kg	32	-
Male Kata	31	-
Male Kumite -60 Kg	32	-
Male Kumite -67 Kg	32	-
Male Kumite -75 Kg	31	-
Male Kumite -84 Kg	32	-
Male Kumite 84+ Kg	32	-
Totals:	378	0

FEMALE KATA



Karate World Championships - Individual World Cha ..



ENTRIES BY WEIGHT CATEGORY

Female Kata

As of 2 DEC 2025

Code	ID	Gender	Name	Seeding
ALG	ALG11679	F	DAHLEB NARIMENE	5
AUS	AUS2172	F	DIMOVSKA STEPHANIE	6
BEL	BEL02370	F	MANCA CHIARA	7
BRA	BRA03318	F	HENRIQUE GABRIELLE	8
BUR	BUR2036	F	ROMBA ANICHA	9
CAN	CAN2109	F	LAOS-LOO CLAUDIA	10
CHN	CHN2455	F	TAO YIWEI	23
COL	COL2228	F	ZAPATA MACHADO VALENTINA	11
CZE	CZE213	F	MISKOVA VERONIKA	12
EGY	EGY387	F	HESHAM AYA	13
ESP	ESP02672	F	GARCIA LOZANO PAOLA	28
FRA	FRA02938	F	TAILY HELVETIA	14
GER	GER289	F	BLEUL JASMIN	15
GRE	GRE308	F	XENOU GEORGIA-ARCHONTIA	16
HKG	HKG177	F	LAU MO SHEUNG GRACE	1
IRI	IRI287	F	SADEGHI DASTAK FATEMEH	17
ITA	ITA308	F	D ONOFRIO TERRYANA	3
JPN	JPN2451	F	ONO MAHO	2
MAR	MAR2034	F	EN-NESYRY AYA	20
MAS	MAS02384	F	LOVELLY ANNE ROBBERTH	18
MEX	MEX2350	F	QUIROZ CASTILLO YANETH	19
NEP	NEP003280	F	THING SANU MAYA	21
NZL	NZL184	F	WIGG HOLLY	22
PHI	PHI02129	F	ALFORTE SAKURA	24
POR	POR228	F	CRUZ ANA	25
SGP	SGP02154	F	LEONG WAI YEE SHANNON	26
SVK	SVK03126	F	FIALKOVA SOFIA	27
SWE	SWE185	F	KARLSSON MIA	29
TUR	TUR713	F	BOZAN DILARA	30
USA	USA196	F	KOKUMAI SAKURA	4
VEN	VEN02559	F	OLIGINO DIANA	31

Female Kata - Round Robin (each against each)

Karate World Championships - Individual World Championships - Cairo 2025, 3894+XV8, Al Estad, Qesm Than Madinet Nasr, Cairo Governorate 4436020, EGY

Tatami

Pool

1/8

1	 (*28) GARCIA LOZANO P. (ESP)	047 Kururunfa #1 / 27.11	39.80	 (*28) GARCIA LOZANO P. (ESP)
2	 (*9) ROMBA A. (BUR)	068 Papuren	31.00	
3	 (*31) OLIGINO D. (VEN)	009 Chibana No Kushanku #2 / 27.11	38.70	 (*23) TAO Y. (CHN)
4	 (*23) TAO Y. (CHN)	009 Chibana No Kushanku	39.80	
5	 (*9) ROMBA A. (BUR)	099 Unsu #5 / 27.11	0	 (*31) OLIGINO D. (VEN)
6	 (*31) OLIGINO D. (VEN)	043 Kishimoto No Kushanku	40.10	
7	 (*28) GARCIA LOZANO P. (ESP)	092 Suparinpei #6 / 27.11	41.40	 (*28) GARCIA LOZANO P. (ESP)
8	 (*23) TAO Y. (CHN)	068 Papuren	40.30	
9	 (*28) GARCIA LOZANO P. (ESP)	009 Chibana No Kushanku #9 / 27.11	42.00	 (*28) GARCIA LOZANO P. (ESP)
10	 (*31) OLIGINO D. (VEN)	092 Suparinpei	40.00	
11	 (*9) ROMBA A. (BUR)	046 Kousukun Sho #10 / 27.11	31.90	 (*23) TAO Y. (CHN)
12	 (*23) TAO Y. (CHN)	047 Kururunfa	38.40	

1. GARCIA LOZANO PAOLA (ESP)
2. TAO YIWEI (CHN)
3. OLIGINO DIANA (VEN)
4. ROMBA ANICHA (BUR)

1. LAU MO SHEUNG GRACE (HKG)
2. ONO MAHO (JPN)
3. D ONOFRIO TERRYANA (ITA)
3. HESHAM AYA (EGY)
5. KOKUMAI SAKURA (USA)
5. XENOU GEORGIA-ARCHONTIA (GRE)
7. CRUZ ANA (POR)
7. MANCA CHIARA (BEL)

*Seeded

Referees:			











Female Kata - Round Robin (each against each)

Karate World Championships - Individual World Championships - Cairo 2025, 3894+XV8, Al Estad, Qesm Than Madinet Nasr, Cairo Governorate 4436020, EGY

Tatami

Pool

2/8

1	 (*26) LEONG W. (SGP)	002 Anan Dai #3 / 27.11	38.60	 (*26) LEONG W. (SGP)
2	 (*10) LAOS-LOO C. (CAN)	068 Papuren	38.50	
3	 (*12) MISKOVA V. (CZE)	047 Kururunfa #4 / 27.11	38.80	 (*3) D ONOFRIO T. (ITA)
4	 (*3) D ONOFRIO T. (ITA)	047 Kururunfa	40.70	
5	 (*10) LAOS-LOO C. (CAN)	008 Chatanyara Kushanku #7 / 27.11	38.70	 (*12) MISKOVA V. (CZE)
6	 (*12) MISKOVA V. (CZE)	068 Papuren	39.20	
7	 (*26) LEONG W. (SGP)	092 Suparinpei #8 / 27.11	38.50	 (*3) D ONOFRIO T. (ITA)
8	 (*3) D ONOFRIO T. (ITA)	009 Chibana No Kushanku	41.00	
9	 (*26) LEONG W. (SGP)	064 Ohan Dai #11 / 27.11	39.10	 (*26) LEONG W. (SGP)
10	 (*12) MISKOVA V. (CZE)	052 Matsumura Bassai	37.80	
11	 (*10) LAOS-LOO C. (CAN)	092 Suparinpei #12 / 27.11	38.60	 (*3) D ONOFRIO T. (ITA)
12	 (*3) D ONOFRIO T. (ITA)	008 Chatanyara Kushanku	39.90	

1. D ONOFRIO TERRYANA (ITA)
2. LEONG WAI YEE SHANNON (SGP)
3. MISKOVA VERONIKA (CZE)
4. LAOS-LOO CLAUDIA (CAN)

1. LAU MO SHEUNG GRACE (HKG)
2. ONO MAHO (JPN)
3. D ONOFRIO TERRYANA (ITA)
3. HESHAM AYA (EGY)
5. KOKUMAI SAKURA (USA)
5. XENOU GEORGIA-ARCHONTIA (GRE)
7. CRUZ ANA (POR)
7. MANCA CHIARA (BEL)

*Seeded

Referees:			

Female Kata - Round Robin (each against each)

Karate World Championships - Individual World Championships - Cairo 2025, 3894+XV8, Al Estad, Qesm Than Madinet Nasr, Cairo Governorate 4436020, EGY

Tatami

Pool

3/8

1	 (*24) ALFORTE S. (PHI)	067 Paiku #73 / 27.11	39.60	 (*24) ALFORTE S. (PHI)	064 Ohan Dai
2	 (*22) WIGG H. (NZL)	043 Kishimoto No Kushan	36.60		
3	 (*19) QUIROZ CASTILLO Y. (MEX)	009 Chibana No Kushanku #74 / 27.11	36.60	 (*7) MANCA C. (BEL)	092 Suparinpei
4	 (*7) MANCA C. (BEL)	068 Papuren	39.00		
5	 (*22) WIGG H. (NZL)	008 Chatanyara Kushanku #77 / 27.11	37.20	 (*19) QUIROZ CASTILLO Y. (MEX)	
6	 (*19) QUIROZ CASTILLO Y. (MEX)	068 Papuren	37.60		
7	 (*24) ALFORTE S. (PHI)	064 Ohan Dai #78 / 27.11	38.90	 (*24) ALFORTE S. (PHI)	
8	 (*7) MANCA C. (BEL)	092 Suparinpei	38.30		
9	 (*24) ALFORTE S. (PHI)	009 Chibana No Kushanku #81 / 27.11	39.60	 (*24) ALFORTE S. (PHI)	
10	 (*19) QUIROZ CASTILLO Y. (MEX)	008 Chatanyara Kushanku	36.80		
11	 (*22) WIGG H. (NZL)	068 Papuren #82 / 27.11	36.70	 (*7) MANCA C. (BEL)	
12	 (*7) MANCA C. (BEL)	097 Tomari Bassai	38.70		

1. ALFORTE SAKURA (PHI)
2. MANCA CHIARA (BEL)
3. QUIROZ CASTILLO YANETH (MEX)
4. WIGG HOLLY (NZL)

1. LAU MO SHEUNG GRACE (HKG)
2. ONO MAHO (JPN)
3. D ONOFRIO TERRYANA (ITA)
3. HESHAM AYA (EGY)
5. KOKUMAI SAKURA (USA)
5. XENOU GEORGIA-ARCHONTIA (GRE)
7. CRUZ ANA (POR)
7. MANCA CHIARA (BEL)

*Seeded

Referees:			



















Female Kata - Round Robin (each against each)

Karate World Championships - Individual World Championships - Cairo 2025, 3894+XV8, Al Estad, Qesm Than Madinet Nasr, Cairo Governorate 4436020, EGY

Tatami

Pool

4/8

1	 (*5) DAHLEB N. (ALG)	020 Gojushiho Dai #75 / 27.11	38.60	 (*16) XENOU G. (GRE)
2	 (*16) XENOU G. (GRE)	002 Anan Dai	38.90	
3	 (*29) KARLSSON M. (SWE)	052 Matsumura Bassai #76 / 27.11	37.90	 (*2) ONO M. (JPN)
4	 (*2) ONO M. (JPN)	061 Nipaipo	41.00	
5	 (*16) XENOU G. (GRE)	009 Chibana No Kushanku #79 / 27.11	39.10	 (*16) XENOU G. (GRE)
6	 (*29) KARLSSON M. (SWE)	047 Kururunfa	37.00	
7	 (*5) DAHLEB N. (ALG)	015 Gankaku #80 / 27.11	38.40	 (*2) ONO M. (JPN)
8	 (*2) ONO M. (JPN)	092 Suparinpei	40.90	
9	 (*5) DAHLEB N. (ALG)	099 Unsu #83 / 27.11	39.00	 (*5) DAHLEB N. (ALG)
10	 (*29) KARLSSON M. (SWE)	068 Papuren	37.90	
11	 (*16) XENOU G. (GRE)	047 Kururunfa #84 / 27.11	39.60	 (*2) ONO M. (JPN)
12	 (*2) ONO M. (JPN)	008 Chatanyara Kushanku	41.30	

1. ONO MAHO (JPN)
2. XENOU GEORGIA-ARCHONTIA (GRE)
3. DAHLEB NARIMENE (ALG)
4. KARLSSON MIA (SWE)

1. LAU MO SHEUNG GRACE (HKG)
2. ONO MAHO (JPN)
3. D ONOFRIO TERRYANA (ITA)
3. HESHAM AYA (EGY)
5. KOKUMAI SAKURA (USA)
5. XENOU GEORGIA-ARCHONTIA (GRE)
7. CRUZ ANA (POR)
7. MANCA CHIARA (BEL)

*Seeded

Referees:			

Female Kata - Round Robin (each against each)

Karate World Championships - Individual World Championships - Cairo 2025, 3894+XV8, Al Estad, Qesm Than Madinet Nasr, Cairo Governorate 4436020, EGY

Tatami

Pool

5/8

1	(*20) EN-NESYRY A. (MAR)	041 Kanku Sho #145 / 27.11	38.40	(*20) EN-NESYRY A. (MAR)
2	(*27) FIALKOVA S. (SVK)	009 Chibana No Kushanku	37.20	
3	(*6) DIMOVSKA S. (AUS)	068 Papuren #146 / 27.11	37.60	(*17) SADEGHI DASTAK F. (IRI)
4	(*17) SADEGHI DASTAK F. (IRI)	092 Suparinpei	39.30	
5	(*27) FIALKOVA S. (SVK)	068 Papuren #149 / 27.11	38.00	(*27) FIALKOVA S. (SVK)
6	(*6) DIMOVSKA S. (AUS)	092 Suparinpei	37.90	
7	(*20) EN-NESYRY A. (MAR)	020 Gojushiho Dai #150 / 27.11	38.20	(*17) SADEGHI DASTAK F. (IRI)
8	(*17) SADEGHI DASTAK F. (IRI)	009 Chibana No Kushanku	39.50	
9	(*20) EN-NESYRY A. (MAR)	021 Gojushiho Sho #153 / 27.11	38.30	(*20) EN-NESYRY A. (MAR)
10	(*6) DIMOVSKA S. (AUS)	008 Chatanyara Kushanku	36.80	
11	(*27) FIALKOVA S. (SVK)	002 Anan Dai #154 / 27.11	37.50	(*17) SADEGHI DASTAK F. (IRI)
12	(*17) SADEGHI DASTAK F. (IRI)	002 Anan Dai	39.20	

1. SADEGHI DASTAK FATEMEH (IRI)
2. EN-NESYRY AYA (MAR)
3. FIALKOVA SOFIA (SVK)
4. DIMOVSKA STEPHANIE (AUS)

1. LAU MO SHEUNG GRACE (HKG)
2. ONO MAHO (JPN)
3. D ONOFRIO TERRYANA (ITA)
3. HESHAM AYA (EGY)
5. KOKUMAI SAKURA (USA)
5. XENOU GEORGIA-ARCHONTIA (GRE)
7. CRUZ ANA (POR)
7. MANCA CHIARA (BEL)

*Seeded

Referees:			

Female Kata - Round Robin (each against each)

Karate World Championships - Individual World Championships - Cairo 2025, 3894+XV8, Al Estad, Qesm Than Madinet Nasr, Cairo Governorate 4436020, EGY

Tatami

Pool

6/8

1	(*15) BLEUL J. (GER)	078 Sansai #147 / 27.11	38.10	(*8) HENRIQUE G. (BRA)
2	(*8) HENRIQUE G. (BRA)	068 Papuren	39.70	
3	(*30) BOZAN D. (TUR)	068 Papuren #148 / 27.11	38.80	(*4) KOKUMAI S. (USA)
4	(*4) KOKUMAI S. (USA)	068 Papuren	39.10	
5	(*8) HENRIQUE G. (BRA)	009 Chibana No Kushanku #151 / 27.11	38.60	(*8) HENRIQUE G. (BRA)
6	(*30) BOZAN D. (TUR)	047 Kururunfa	38.20	
7	(*15) BLEUL J. (GER)	021 Gojushiho Sho #152 / 27.11	38.30	(*4) KOKUMAI S. (USA)
8	(*4) KOKUMAI S. (USA)	009 Chibana No Kushanku	38.90	
9	(*15) BLEUL J. (GER)	020 Gojushiho Dai #155 / 27.11	39.00	(*15) BLEUL J. (GER)
10	(*30) BOZAN D. (TUR)	002 Anan Dai	38.20	
11	(*8) HENRIQUE G. (BRA)	008 Chatanyara Kushanku #156 / 27.11	39.90	(*8) HENRIQUE G. (BRA)
12	(*4) KOKUMAI S. (USA)	047 Kururunfa	39.40	

1. HENRIQUE GABRIELLE (BRA)
2. KOKUMAI SAKURA (USA)
3. BLEUL JASMIN (GER)
4. BOZAN DILARA (TUR)

1. LAU MO SHEUNG GRACE (HKG)
2. ONO MAHO (JPN)
3. D ONOFRIO TERRYANA (ITA)
3. HESHAM AYA (EGY)
5. KOKUMAI SAKURA (USA)
5. XENOU GEORGIA-ARCHONTIA (GRE)
7. CRUZ ANA (POR)
7. MANCA CHIARA (BEL)

*Seeded

Referees:			

Female Kata - Round Robin (each against each)

Karate World Championships - Individual World Championships - Cairo 2025, 3894+XV8, Al Estad, Qesm Than Madinet Nasr, Cairo Governorate 4436020, EGY

Tatami

Pool

7/8

1	 (*11) ZAPATA MACHADO V. (COL)	092 Suparinpei #217 / 27.11	38.80	 (*11) ZAPATA MACHADO V. (COL)
2	 (*21) THING S. (NEP)	068 Papuren	36.10	
3	 (*13) HESHAM A. (EGY)	020 Gojushiho Dai #218 / 27.11	39.20	 (*13) HESHAM A. (EGY)
4	 (*14) TAILY H. (FRA)	099 Unsu	38.00	
5	 (*21) THING S. (NEP)	008 Chatanyara Kushanku #220 / 27.11	35.50	 (*13) HESHAM A. (EGY)
6	 (*13) HESHAM A. (EGY)	041 Kanku Sho	39.40	
7	 (*11) ZAPATA MACHADO V. (COL)	008 Chatanyara Kushanku #221 / 27.11	39.10	 (*14) TAILY H. (FRA)
8	 (*14) TAILY H. (FRA)	020 Gojushiho Dai	39.40	
9	 (*11) ZAPATA MACHADO V. (COL)	009 Chibana No Kushanku #223 / 27.11	39.00	 (*13) HESHAM A. (EGY)
10	 (*13) HESHAM A. (EGY)	099 Unsu	39.90	
11	 (*21) THING S. (NEP)	002 Anan Dai #224 / 27.11	36.80	 (*14) TAILY H. (FRA)
12	 (*14) TAILY H. (FRA)	041 Kanku Sho	39.50	

1. HESHAM AYA (EGY)
2. TAILY HELVETIA (FRA)
3. ZAPATA MACHADO VALENTINA (COL)
4. THING SANU MAYA (NEP)

1. LAU MO SHEUNG GRACE (HKG)
2. ONO MAHO (JPN)
3. D ONOFRIO TERRYANA (ITA)
3. HESHAM AYA (EGY)
5. KOKUMAI SAKURA (USA)
5. XENOU GEORGIA-ARCHONTIA (GRE)
7. CRUZ ANA (POR)
7. MANCA CHIARA (BEL)

*Seeded









Referees:			

Female Kata - Round Robin (each against each)

Karate World Championships - Individual World Championships - Cairo 2025, 3894+XV8, Al Estad, Qesm Than Madinet Nasr, Cairo Governorate 4436020, EGY

Tatami

Pool
8/8

1	 (*18) LOVELLY ANNE R. (MAS)	002 Anan Dai #219 / 27.11	38	 (*25) CRUZ A. (POR)
2	 (*25) CRUZ A. (POR)	002 Anan Dai	40.00	
3	 (*18) LOVELLY ANNE R. (MAS)	001 Anan #225 / 27.11	37	 (*1) LAU M. (HKG)
4	 (*1) LAU M. (HKG)	098 Unshu	40.90	
5	 (*25) CRUZ A. (POR)	047 Kururunfa #222 / 27.11	39	 (*1) LAU M. (HKG)
6	 (*1) LAU M. (HKG)	097 Tomari Bassai	41.20	

1. LAU MO SHEUNG GRACE (HKG)
2. CRUZ ANA (POR)
3. LOVELLY ANNE ROBBERTH (MAS)

1. LAU MO SHEUNG GRACE (HKG)
2. ONO MAHO (JPN)
3. D ONOFRIO TERRYANA (ITA)
3. HESHAM AYA (EGY)
5. KOKUMAI SAKURA (USA)
5. XENOU GEORGIA-ARCHONTIA (GRE)
7. CRUZ ANA (POR)
7. MANCA CHIARA (BEL)

*Seeded

Referees:			

Pool winner-Female Kata

Karate World Championships - Individual World Championships - Cairo 2025, 3894+XV8, Al Estad, Qesm Than Madinet Nasr, Cairo Governorate 4436020, EGY

Tatami

Pool
1/1

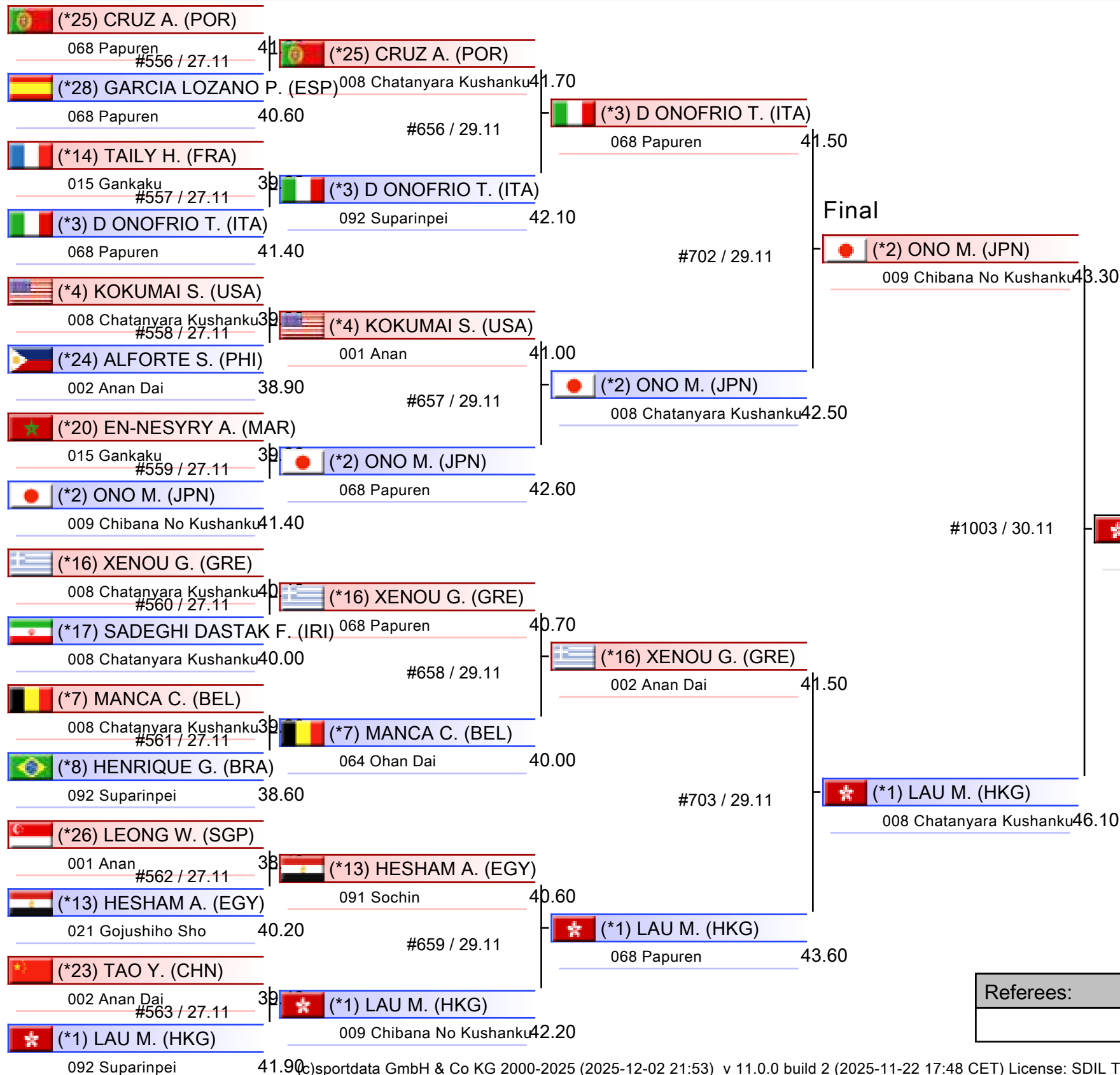

1. LAU MO SHEUNG GRACE (HKG)
2. ONO MAHO (JPN)
3. D ONOFRIO TERRYANA (ITA)
3. HESHAM AYA (EGY)
5. KOKUMAI SAKURA (USA)
5. XENOU GEORGIA-ARCHONTIA (GRE)
7. CRUZ ANA (POR)
7. MANCA CHIARA (BEL)

*Seeded

Referees:			

Female Kata

Karate World Championships - Individual World Championships - Cairo 2025

Tatami

Pool
1,2,3,4,5,6,7,8

(c)sportdata GmbH & Co KG 2000-2025 (2025-12-02 21:54) v 11.0.0 build 2 (2025-11-22 17:48 CET) License: SDIL TVG ODF (expire 2026-01-23)

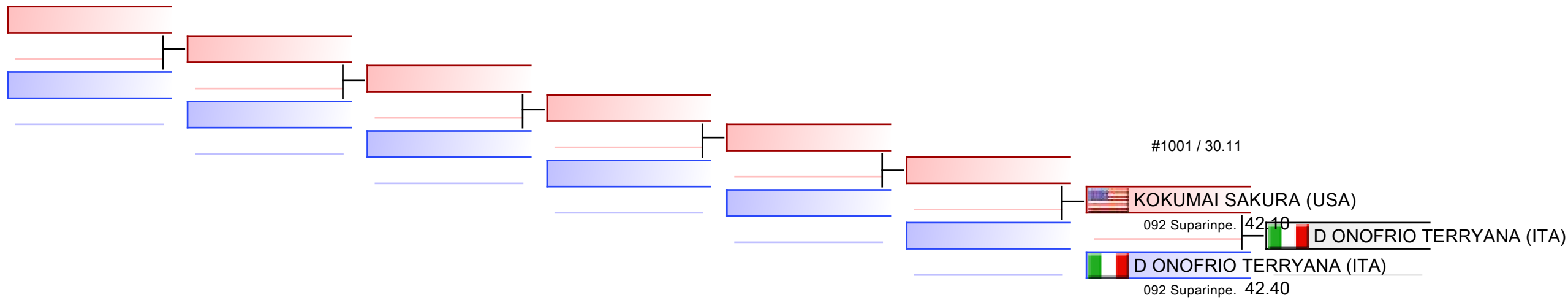

REPECHAGE: (1,2,3,4,5,6,7,8)

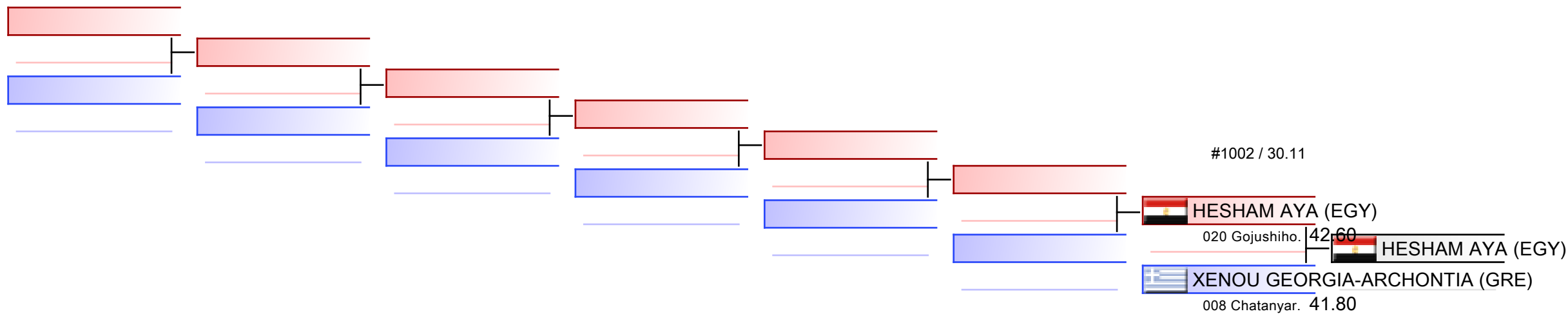

Referees:							
-----------	--	--	--	--	--	--	--



Karate World Championships - Individual World
Championships - Cairo 2025 - 2025-11-27



Official Results

Female Kata			
1	LAU MO SHEUNG GRACE		HKG - HONG KONG, CHINA
2	ONO MAHO		JPN - JAPAN
3	D ONOFRIO TERRYANA		ITA - ITALY
3	HESHAM AYA		EGY - EGYPT
5	KOKUMAI SAKURA		USA - UNITED STATES
5	XENOU GEORGIA-ARCHONTIA		GRE - GREECE
7	CRUZ ANA		POR - PORTUGAL
7	MANCA CHIARA		BEL - BELGIUM

FEMALE KUMITE -50 KG



Karate World Championships - Individual World Cha ..



ENTRIES BY WEIGHT CATEGORY

Female Kumite -50 Kg

As of 2 DEC 2025

Code	ID	Gender	Name	Seeding
ALG	ALG02678	F	OUIKENE CYLIA	1
ANG	ANG002061	F	FRANCOIS ELISA	5
AUS	AUS02729	F	TRAN CECILIA	6
BUL	BUL2210	F	TSANEVA TEODORA	7
CAN	CAN2249	F	LAHYANSSA YAMINA	8
COL	COL2195	F	CARDENAS BALCAZAR SOFIA	9
CRO	CRO2209	F	SGARDELLI EMA	3
ECU	ECU2099	F	ALVARADO LILI	10
EGY	EGY2528	F	SALAMA REEM AHMED	11
ESA	ESA2056	F	IZAGUIRRE GABRIELLA	12
ESP	ESP03582	F	BENTAMA-SERROUKH JEBARI INSAF	27
FRA	FRA2249	F	BONNARDE TIPHAINE	13
GEO	GEO02669	F	VASADZE MARIAMI	14
GER	GER2252	F	HUBRICH SHARA	15
GRE	GRE02642	F	PAPPA CHRISTINA TRIADA	16
HKG	HKG191	F	TSANG YEE TING	17
IRI	IRI2134	F	BAHMANYAR SARA	4
ITA	ITA376	F	PERFETTO ERMINIA	2
JPN	JPN02704	F	OKAZAKI AIKA	18
KSA	KSA03183	F	ALRASHED NORAH	24
LAT	LAT2073	F	MIHAILOVA ALEKSANDRA	19
MAS	MAS02418	F	CHANDRAN SHAHMALARANI	20
MEX	MEX2030	F	SALCIDO KATIA	21
NGR	NGR2029	F	OKORO LOVETH NGOZI	22
POR	POR2187	F	RODRIGUES CATARINA	23
RSA	RSA2262	F	ROETZ MARINDA	26
SUI	SUI267	F	SCHAERER MAYA	28
SVK	SVK2293	F	VARGOVA NATALIA	25
UKR	UKR2269	F	PALASHEVSKA YULIIA	29
UZB	UZB02597	F	ALIMARDANOVA GULSHAN	30
VEN	VEN297	F	SALAZAR CAMACHO YORGELIS	31















Female Kumite -50 Kg - Round Robin (each against each)

Karate World Championships - Individual World Championships - Cairo 2025, 3894+XV8, Al Estad, Qesm Than Madinet Nasr, Cairo Governorate 4436020, EGY

Tatami

Pool

1/8

1	 (*7) TSANEVA T. (BUL)	
	#25 / 27.11	4  (*7) TSANEVA T. (BUL)
2	 (*5) FRANCOIS E. (ANG)	
	0	
	PTS	
3	 (*31) SALAZAR CAMACHO Y. (VEN)	
	#26 / 27.11	4  (*31) SALAZAR CAMACHO Y. (VEN)
4	 (*20) CHANDRAN S. (MAS)	
	1	
5	 (*5) FRANCOIS E. (ANG)	
	#29 / 27.11	0  (*31) SALAZAR CAMACHO Y. (VEN)
6	 (*31) SALAZAR CAMACHO Y. (VEN)	
	7	
7	 (*7) TSANEVA T. (BUL)	
	#30 / 27.11	0  (*20) CHANDRAN S. (MAS)
8	 (*20) CHANDRAN S. (MAS)	
	1	
9	 (*7) TSANEVA T. (BUL)	
	#33 / 27.11	0  (*31) SALAZAR CAMACHO Y. (VEN)
10	 (*31) SALAZAR CAMACHO Y. (VEN)	
	0	
11	 (*5) FRANCOIS E. (ANG)	
	#34 / 27.11	1  (*20) CHANDRAN S. (MAS)
12	 (*20) CHANDRAN S. (MAS)	
	4	

1. SALAZAR CAMACHO YORGELIS (VEN)
2. CHANDRAN SHAHMALARANI (MAS)
3. TSANEVA TEODORA (BUL)
4. FRANCOIS ELISA (ANG)

1. ALIMARDANOVA GULSHAN (UZB)
2. CHANDRAN SHAHMALARANI (MAS)
3. BAHMANYAR SARA (IRI)
3. SALAZAR CAMACHO YORGELIS (VEN)
5. TSANG YEE TING (HKG)
5. ALVARADO LILI (ECU)
7. BONNARDE TIPHAINE (FRA)
7. SALAMA REEM AHMED (EGY)

*Seeded

Referees:			

Female Kumite -50 Kg - Round Robin (each against each)

Karate World Championships - Individual World Championships - Cairo 2025, 3894+XV8, Al Estad, Qesm Than Madinet Nasr, Cairo Governorate 4436020, EGY

Tatami

Pool

2/8

1	(*26) ROETZ M. (RSA)		
	#27 / 27.11	3	(*26) ROETZ M. (RSA)
2	(*18) OKAZAKI A. (JPN)		
	HA	2	
3	(*16) PAPP A C. (GRE)		
	#28 / 27.11	4	(*16) PAPP A C. (GRE)
4	(*3) SGARDELLI E. (CRO)		
	PTS	0	
5	(*18) OKAZAKI A. (JPN)		
	#31 / 27.11	3	(*18) OKAZAKI A. (JPN)
6	(*16) PAPP A C. (GRE)		
		1	
7	(*26) ROETZ M. (RSA)		
	#32 / 27.11	2	(*3) SGARDELLI E. (CRO)
8	(*3) SGARDELLI E. (CRO)		
	PTS	5	
9	(*26) ROETZ M. (RSA)		
	#35 / 27.11	2	(*16) PAPP A C. (GRE)
10	(*16) PAPP A C. (GRE)		
	PTS	3	
11	(*18) OKAZAKI A. (JPN)		
	#36 / 27.11	3	(*18) OKAZAKI A. (JPN)
12	(*3) SGARDELLI E. (CRO)		
		1	

1. OKAZAKI AIKA (JPN)
2. PAPP A CHRISTINA TRIADA (GRE)
3. SGARDELLI EMA (CRO)
4. ROETZ MARINDA (RSA)

1. ALIMARDANOVA GULSHAN (UZB)
2. CHANDRAN SHAHMALARANI (MAS)
3. BAHMANYAR SARA (IRI)
3. SALAZAR CAMACHO YORGELIS (VEN)
5. TSANG YEE TING (HKG)
5. ALVARADO LILI (ECU)
7. BONNARDE TIPHAINE (FRA)
7. SALAMA REEM AHMED (EGY)

*Seeded

Referees:			

Female Kumite -50 Kg - Round Robin (each against each)

Karate World Championships - Individual World Championships - Cairo 2025, 3894+XV8, Al Estad, Qesm Than Madinet Nasr, Cairo Governorate 4436020, EGY

Tatami

Pool

3/8

1	(*6) TRAN C. (AUS)	1	(*13) BONNARDE T. (FRA)
	#97 / 27.11s		
2	(*13) BONNARDE T. (FRA)	3	
3	(*12) IZAGUIRRE G. (ESA)	1	(*27) BENTAMA-SERROUKH JEBARI I. (ESP)
	#98 / 27.11s		
4	(*27) BENTAMA-SERROUKH JEBARI I. (ESP)	2	
	PTS		
5	(*13) BONNARDE T. (FRA)	5	(*13) BONNARDE T. (FRA)
	#101 / 27.11		
6	(*12) IZAGUIRRE G. (ESA)	3	
7	(*6) TRAN C. (AUS)	0	(*27) BENTAMA-SERROUKH JEBARI I. (ESP)
	#102 / 27.11s		
8	(*27) BENTAMA-SERROUKH JEBARI I. (ESP)	3	
9	(*6) TRAN C. (AUS)	0	(*12) IZAGUIRRE G. (ESA)
	#105 / 27.11s		
10	(*12) IZAGUIRRE G. (ESA)	1	
	PTS		
11	(*13) BONNARDE T. (FRA)	2	(*13) BONNARDE T. (FRA)
	#106 / 27.11		
12	(*27) BENTAMA-SERROUKH JEBARI I. (ESP)	1	

1. BONNARDE TIPHAINE (FRA)
2. BENTAMA-SERROUKH JEBARI INSAF (ESP)
3. IZAGUIRRE GABRIELLA (ESA)
4. TRAN CECILIA (AUS)

1. ALIMARDANOVA GULSHAN (UZB)
2. CHANDRAN SHAHMALARANI (MAS)
3. BAHMANYAR SARA (IRI)
3. SALAZAR CAMACHO YORGELIS (VEN)
5. TSANG YEE TING (HKG)
5. ALVARADO LILI (ECU)
7. BONNARDE TIPHAINE (FRA)
7. SALAMA REEM AHMED (EGY)

*Seeded

Referees:			



Female Kumite -50 Kg - Round Robin (each against each)

Karate World Championships - Individual World Championships - Cairo 2025, 3894+XV8, Al Estad, Qesm Than Madinet Nasr, Cairo Governorate 4436020, EGY

Tatami

Pool

4/8

1	 (*25) VARGOVA N. (SVK)	
	#99 / 27.11	2
2	 (*17) TSANG Y. (HKG)	2
3	 (*22) OKORO L. (NGR)	0
	#100 / 27.11	0
4	 (*2) PERFETTO E. (ITA)	7
	PTS	
5	 (*17) TSANG Y. (HKG)	2
	#103 / 27.11	2
6	 (*22) OKORO L. (NGR)	1
7	 (*25) VARGOVA N. (SVK)	0
	#104 / 27.11	0
8	 (*2) PERFETTO E. (ITA)	4
	PTS	
9	 (*25) VARGOVA N. (SVK)	9
	#107 / 27.11	9
10	 (*22) OKORO L. (NGR)	1
	SH	
11	 (*17) TSANG Y. (HKG)	3
	#108 / 27.11	3
12	 (*2) PERFETTO E. (ITA)	3

1. TSANG YEE TING (HKG)
2. PERFETTO ERMINIA (ITA)
3. VARGOVA NATALIA (SVK)
4. OKORO LOVETH NGOZI (NGR)

1. ALIMARDANOVA GULSHAN (UZB)
2. CHANDRAN SHAHMALARANI (MAS)
3. BAHMANYAR SARA (IRI)
3. SALAZAR CAMACHO YORGELIS (VEN)
5. TSANG YEE TING (HKG)
5. ALVARADO LILI (ECU)
7. BONNARDE TIPHAINE (FRA)
7. SALAMA REEM AHMED (EGY)

*Seeded

Referees:			

Female Kumite -50 Kg - Round Robin (each against each)

Karate World Championships - Individual World Championships - Cairo 2025, 3894+XV8, Al Estad, Qesm Than Madinet Nasr, Cairo Governorate 4436020, EGY

Tatami

Pool

5/8

1	(*11) SALAMA R. (EGY)	#169 / 27.11	6	(*11) SALAMA R. (EGY)
2	(*24) ALRASHED N. (KSA)		1	
3	(*8) LAHYANSSA Y. (CAN)	#170 / 27.11	2	(*8) LAHYANSSA Y. (CAN)
4	(*23) RODRIGUES C. (POR)		0	
5	(*24) ALRASHED N. (KSA)	#173 / 27.11	0	(*8) LAHYANSSA Y. (CAN)
6	(*8) LAHYANSSA Y. (CAN)		4	
7	(*11) SALAMA R. (EGY)	#174 / 27.11	2	
8	(*23) RODRIGUES C. (POR)		2	
9	(*11) SALAMA R. (EGY)	#177 / 27.11	5	(*11) SALAMA R. (EGY)
10	(*8) LAHYANSSA Y. (CAN)		3	
11	(*24) ALRASHED N. (KSA)	#178 / 27.11	2	(*23) RODRIGUES C. (POR)
12	(*23) RODRIGUES C. (POR)		5	

1. SALAMA REEM AHMED (EGY)
2. LAHYANSSA YAMINA (CAN)
3. RODRIGUES CATARINA (POR)
4. ALRASHED NORAH (KSA)

1. ALIMARDANOVA GULSHAN (UZB)
2. CHANDRAN SHAHMALARANI (MAS)
3. BAHMANYAR SARA (IRI)
3. SALAZAR CAMACHO YORGELIS (VEN)
5. TSANG YEE TING (HKG)
5. ALVARADO LILI (ECU)
7. BONNARDE TIPHAINE (FRA)
7. SALAMA REEM AHMED (EGY)

*Seeded

Referees:			

Female Kumite -50 Kg - Round Robin (each against each)

Karate World Championships - Individual World Championships - Cairo 2025, 3894+XV8, Al Estad, Qesm Than Madinet Nasr, Cairo Governorate 4436020, EGY

Tatami

Pool

6/8

1	(*28) SCHAERER M. (SUI)	#171 / 27.11	1	(*28) SCHAERER M. (SUI)
2	(*14) VASADZE M. (GEO)		1	
3	(*21) SALCIDO K. (MEX)	#172 / 27.11	3	(*4) BAHMANYAR S. (IRI)
4	(*4) BAHMANYAR S. (IRI)		3	
5	(*14) VASADZE M. (GEO)	#175 / 27.11	7	(*14) VASADZE M. (GEO)
6	(*21) SALCIDO K. (MEX)		3	
7	(*28) SCHAERER M. (SUI)	#176 / 27.11	2	(*4) BAHMANYAR S. (IRI)
8	(*4) BAHMANYAR S. (IRI)		8	
9	(*28) SCHAERER M. (SUI)	#179 / 27.11	1	(*28) SCHAERER M. (SUI)
10	(*21) SALCIDO K. (MEX)		1	
11	(*14) VASADZE M. (GEO)	#180 / 27.11	5	(*14) VASADZE M. (GEO)
12	(*4) BAHMANYAR S. (IRI)		3	

1. BAHMANYAR SARA (IRI)
2. SCHAERER MAYA (SUI)
3. VASADZE MARIAMI (GEO)
4. SALCIDO KATIA (MEX)

1. ALIMARDANOVA GULSHAN (UZB)
2. CHANDRAN SHAHMALARANI (MAS)
3. BAHMANYAR SARA (IRI)
3. SALAZAR CAMACHO YORGELIS (VEN)
5. TSANG YEE TING (HKG)
5. ALVARADO LILI (ECU)
7. BONNARDE TIPHAINE (FRA)
7. SALAMA REEM AHMED (EGY)

*Seeded

Referees:			

Female Kumite -50 Kg - Round Robin (each against each)

Karate World Championships - Individual World Championships - Cairo 2025, 3894+XV8, Al Estad, Qesm Than Madinet Nasr, Cairo Governorate 4436020, EGY

Tatami

Pool

7/8

1	(*30) ALIMARDANOVA G. (UZB)	4	(*30) ALIMARDANOVA G. (UZB)
	#238 / 27.11		
2	(*19) MIHAILOVA A. (LAT)	0	
3	(*10) ALVARADO L. (ECU)	1	(*9) CARDENAS BALCAZAR S. (COL)
	#239 / 27.11		
4	(*9) CARDENAS BALCAZAR S. (COL)	4	
5	(*19) MIHAILOVA A. (LAT)	0	(*10) ALVARADO L. (ECU)
	#241 / 27.11		
6	(*10) ALVARADO L. (ECU)	8	
	PTS		
7	(*30) ALIMARDANOVA G. (UZB)	4	(*30) ALIMARDANOVA G. (UZB)
	#242 / 27.11		
8	(*9) CARDENAS BALCAZAR S. (COL)	3	
9	(*30) ALIMARDANOVA G. (UZB)	2	(*10) ALVARADO L. (ECU)
	#244 / 27.11		
10	(*10) ALVARADO L. (ECU)	3	
	PTS		
11	(*19) MIHAILOVA A. (LAT)	2	(*19) MIHAILOVA A. (LAT)
	#245 / 27.11		
12	(*9) CARDENAS BALCAZAR S. (COL)	1	

1. ALVARADO LILI (ECU)
2. ALIMARDANOVA GULSHAN (UZB)
3. MIHAILOVA ALEKSANDRA (LAT)
4. CARDENAS BALCAZAR SOFIA (COL)

1. ALIMARDANOVA GULSHAN (UZB)
2. CHANDRAN SHAHMALARANI (MAS)
3. BAHMANYAR SARA (IRI)
3. SALAZAR CAMACHO YORGELIS (VEN)
5. TSANG YEE TING (HKG)
5. ALVARADO LILI (ECU)
7. BONNARDE TIPHAINE (FRA)
7. SALAMA REEM AHMED (EGY)

*Seeded









Referees:			

Female Kumite -50 Kg - Round Robin (each against each)

Karate World Championships - Individual World Championships - Cairo 2025, 3894+XV8, Al Estad, Qesm Than Madinet Nasr, Cairo Governorate 4436020, EGY

Tatami

Pool
8/8

1	 (*29) PALASHEVSKA Y. (UKR)	
	#240 / 27.11	2  (*29) PALASHEVSKA Y. (UKR)
2	 (*15) HUBRICH S. (GER)	
		1
3	 (*29) PALASHEVSKA Y. (UKR)	
	#246 / 27.11	1  (*29) PALASHEVSKA Y. (UKR)
4	 (*1) OUIKENE C. (ALG)	
		0
	PTS	
5	 (*15) HUBRICH S. (GER)	
	#243 / 27.11	1  (*15) HUBRICH S. (GER)
6	 (*1) OUIKENE C. (ALG)	
		0

1. PALASHEVSKA YULIYA (UKR)
2. HUBRICH SHARA (GER)
3. OUIKENE CYLIA (ALG)

1. ALIMARDANOVA GULSHAN (UZB)
2. CHANDRAN SHAHMALARANI (MAS)
3. BAHMANYAR SARA (IRI)
3. SALAZAR CAMACHO YORGELIS (VEN)
5. TSANG YEE TING (HKG)
5. ALVARADO LILI (ECU)
7. BONNARDE TIPHAINE (FRA)
7. SALAMA REEM AHMED (EGY)

*Seeded

Referees:			

Female Kumite -50 Kg

Karate World Championships - Individual World Championships - Cairo 2025

Tatami

Pool

1,2,3,4,5,6,7,8

(c)sportdata GmbH & Co KG 2000-2025 (2025-12-02 21:54) v 11.0.0 build 2 (2025-11-22 17:48 CET) License: SDIL TVG ODF (expire 2026-01-23)

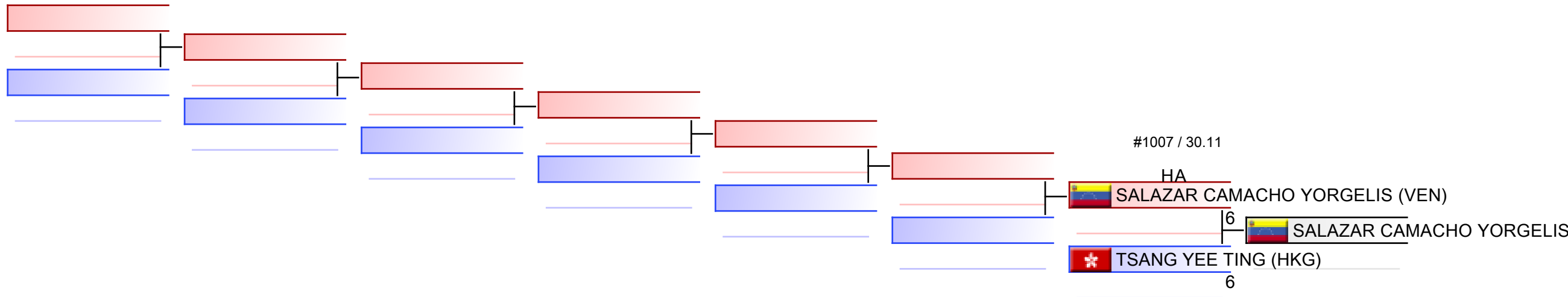

REPECHAGE: (1,2,3,4,5,6,7,8)

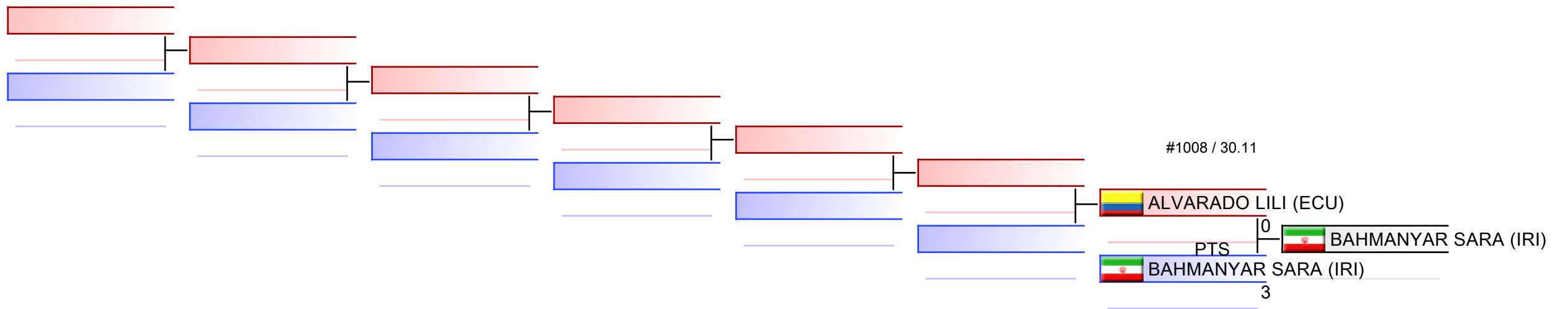

Referees:							
-----------	--	--	--	--	--	--	--



Karate World Championships - Individual World Championships - Cairo 2025 - 2025-11-27



Official Results

Female Kumite -50 Kg			
1	ALIMARDANOVA GULSHAN		UZB - UZBEKISTAN
2	CHANDRAN SHAHMALARANI		MAS - MALAYSIA
3	BAHMANYAR SARA		IRI - ISLAMIC REPUBLIC OF IRAN
3	SALAZAR CAMACHO YORGELIS		VEN - VENEZUELA
5	TSANG YEE TING		HKG - HONG KONG, CHINA
5	ALVARADO LILI		ECU - ECUADOR
7	BONNARDE TIPHAINE		FRA - FRANCE
7	SALAMA REEM AHMED		EGY - EGYPT

FEMALE KUMITE -55 KG



Karate World Championships - Individual World Cha ..



ENTRIES BY WEIGHT CATEGORY

Female Kumite -55 Kg

As of 2 DEC 2025

Code	ID	Gender	Name	Seeding
ALG	ALG02679	F	ABOURICHE LOUIZA	5
AUS	AUS2209	F	LAWRENCE GEORGIE	6
AZE	AZE2201	F	SADIGOVA MADINA	7
BDI	BDI02087	F	ISHIMWE SIFA ALICE	10
BEL	BEL02518	F	EL AIDI AYAH	8
BUL	BUL304	F	GORANOVA IVET	9
CAN	CAN245	F	FURUMOTO-DESHAIES HANA	11
CHI	CHI2015	F	TORO MENESES VALENTINA	2
CHN	CHN02840	F	WEI YUCHUN	27
DOM	DOM2006	F	TERRERO ALCANTARA THALIA	13
EGY	EGY2630	F	YOUSSEF AHLAM	3
ESA	ESA02134	F	IZAGUIRRE GALDAMEZ ESTEFANY RACHEL	14
GEO	GEO2149	F	ZVIADAURI LIZI	15
GER	GER2519	F	BITSCH MIA	4
GRE	GRE2076	F	STOLI MARIA	16
GUA	GUA02145	F	CEVASCO BARRIENTOS FABIANA	17
IND	IND03639	F	ALISHA ALISHA	18
IRI	IRI2481	F	SAADATI FATEME	19
ITA	ITA395	F	LALLO VIOLA	20
JPN	JPN02782	F	KODO RINA	21
KAZ	KAZ2033	F	USSENOVA GULMIRA	22
LUX	LUX124	F	WARLING JENNIFER	23
MAR	MAR02527	F	ELHAYTI CHAIMAE	24
NGR	NGR2105	F	UKOHA-SAMPSON GODFIRST ORIE	26
NZL	NZL2000	F	ALDRIDGE BRITNEY	25
SVK	SVK02345	F	KVASNICOVA NINA	28
SWE	SWE2151	F	ROSENLIND MATILDA	29
TPE	TPE159	F	KU TSUI-PING	12
UKR	UKR240	F	TERLIUGA ANZHELIKA	1
UZB	UZB2293	F	RAKHIMOVA SEVINCH	30
WKF-1	RUS2306	F	CHERNYSHEVA ANNA	31

Female Kumite -55 Kg - Round Robin (each against each)

Karate World Championships - Individual World Championships - Cairo 2025, 3894+XV8, Al Estad, Qesm Than Madinet Nasr, Cairo Governorate 4436020, EGY

Tatami

Pool

1/8

1	(*13) TERRERO ALCANTARA T. (DOM)	
	#49 / 27.11	5 (*13) TERRERO ALCANTARA T. (DOM)
2	(*24) ELHAYTI C. (MAR)	2
	PTS	
3	(*20) LALLO V. (ITA)	
	#50 / 27.11	4 (*20) LALLO V. (ITA)
4	(*28) KVASNICOVA N. (SVK)	2
5	(*24) ELHAYTI C. (MAR)	
	#53 / 27.11	0 (*20) LALLO V. (ITA)
6	(*20) LALLO V. (ITA)	2
7	(*13) TERRERO ALCANTARA T. (DOM)	
	#54 / 27.11	0 (*28) KVASNICOVA N. (SVK)
8	(*28) KVASNICOVA N. (SVK)	5
9	(*13) TERRERO ALCANTARA T. (DOM)	
	#57 / 27.11	1 (*20) LALLO V. (ITA)
10	(*20) LALLO V. (ITA)	4
11	(*24) ELHAYTI C. (MAR)	
	#58 / 27.11	1 (*28) KVASNICOVA N. (SVK)
12	(*28) KVASNICOVA N. (SVK)	5

1. LALLO VIOLA (ITA)
2. KVASNICOVA NINA (SVK)
3. TERRERO ALCANTARA THALIA (DOM)
4. ELHAYTI CHAIMAE (MAR)

1. YOUSSEF AHLAM (EGY)
2. KVASNICOVA NINA (SVK)
3. ABOURICHE LOUIZA (ALG)
3. TERLIUGA ANZHELIKA (UKR)
5. TORO MENESES VALENTINA (CHI)
5. FURUMOTO-DESHAIES HANA (CAN)
7. SAADATI FATEME (IRI)
7. SADIGOVA MADINA (AZE)

*Seeded

Referees:			











Female Kumite -55 Kg - Round Robin (each against each)

Karate World Championships - Individual World Championships - Cairo 2025, 3894+XV8, Al Estad, Qesm Than Madinet Nasr, Cairo Governorate 4436020, EGY

Tatami

Pool

2/8

1	 (*15) ZVIADAURI L. (GEO)	0	 (*11) FURUMOTO-DESHAIES H. (CAN)
	#51 / 27.11	PTS	
2	 (*11) FURUMOTO-DESHAIES H. (CAN)	4	
3	 (*22) USSENOVA G. (KAZ)	2	 (*3) YOUSSEF A. (EGY)
	#52 / 27.11	PTS	
4	 (*3) YOUSSEF A. (EGY)	4	
		PTS	
5	 (*11) FURUMOTO-DESHAIES H. (CAN)	2	 (*11) FURUMOTO-DESHAIES H. (CAN)
	#55 / 27.11	PTS	
6	 (*22) USSENOVA G. (KAZ)	0	
7	 (*15) ZVIADAURI L. (GEO)	1	 (*3) YOUSSEF A. (EGY)
	#56 / 27.11	PTS	
8	 (*3) YOUSSEF A. (EGY)	11	
9	 (*15) ZVIADAURI L. (GEO)	1	 (*22) USSENOVA G. (KAZ)
	#59 / 27.11	PTS	
10	 (*22) USSENOVA G. (KAZ)	9	
11	 (*11) FURUMOTO-DESHAIES H. (CAN)	1	 (*3) YOUSSEF A. (EGY)
	#60 / 27.11	PTS	
12	 (*3) YOUSSEF A. (EGY)	3	

1. YOUSSEF AHLAM (EGY)
2. FURUMOTO-DESHAIES HANA (CAN)
3. USSENOVA GULMIRA (KAZ)
4. ZVIADAURI LIZI (GEO)

1. YOUSSEF AHLAM (EGY)
2. KVASNICOVA NINA (SVK)
3. ABOURICHE LOUIZA (ALG)
3. TERLIUGA ANZHELIKA (UKR)
5. TORO MENESES VALENTINA (CHI)
5. FURUMOTO-DESHAIES HANA (CAN)
7. SAADATI FATEME (IRI)
7. SADIGOVA MADINA (AZE)

*Seeded

Referees:			

Female Kumite -55 Kg - Round Robin (each against each)

Karate World Championships - Individual World Championships - Cairo 2025, 3894+XV8, Al Estad, Qesm Than Madinet Nasr, Cairo Governorate 4436020, EGY

Tatami

Pool

3/8

1	(*6) LAWRENCE G. (AUS)	#121 / 27.11	0	(*19) SAADATI F. (IRI)
2	(*19) SAADATI F. (IRI)	8		
3	(*7) SADIGOVA M. (AZE)	#122 / 27.11	1	(*7) SADIGOVA M. (AZE)
4	(*26) UKOHA-SAMPSON G. (NGR)	0		
5	(*19) SAADATI F. (IRI)	#125 / 27.11	0	
6	(*7) SADIGOVA M. (AZE)	0		
7	(*6) LAWRENCE G. (AUS)	#126 / 27.11	1	(*6) LAWRENCE G. (AUS)
8	(*26) UKOHA-SAMPSON G. (NGR)	0		
9	(*6) LAWRENCE G. (AUS)	#129 / 27.11	0	(*7) SADIGOVA M. (AZE)
10	(*7) SADIGOVA M. (AZE)	9		
11	(*19) SAADATI F. (IRI)	#130 / 27.11	5	(*19) SAADATI F. (IRI)
12	(*26) UKOHA-SAMPSON G. (NGR)	0		

1. SAADATI FATEME (IRI)
2. SADIGOVA MADINA (AZE)
3. LAWRENCE GEORGIE (AUS)
4. UKOHA-SAMPSON GODFIRST ORIE (NGR)

1. YOUSSEF AHLAM (EGY)
2. KVASNICOVA NINA (SVK)
3. ABOURICHE LOUIZA (ALG)
3. TERLIUGA ANZHELIKA (UKR)
5. TORO MENESES VALENTINA (CHI)
5. FURUMOTO-DESHAIES HANA (CAN)
7. SAADATI FATEME (IRI)
7. SADIGOVA MADINA (AZE)

*Seeded

Referees:			

Female Kumite -55 Kg - Round Robin (each against each)

Karate World Championships - Individual World Championships - Cairo 2025, 3894+XV8, Al Estad, Qesm Than Madinet Nasr, Cairo Governorate 4436020, EGY

Tatami

Pool

4/8

1	(*31) CHERNYSHEVA A. (WKF-1)	#123 / 27.11	1	(*31) CHERNYSHEVA A. (WKF-1)
2	(*29) ROSENLIND M. (SWE)		1	
3	(*21) KODO R. (JPN)	#124 / 27.11	1	(*2) TORO MENESES V. (CHI)
4	(*2) TORO MENESES V. (CHI)		1	
5	(*29) ROSENLIND M. (SWE)	#127 / 27.11	1	(*21) KODO R. (JPN)
6	(*21) KODO R. (JPN)		6	
7	(*31) CHERNYSHEVA A. (WKF-1)	#128 / 27.11	0	(*2) TORO MENESES V. (CHI)
8	(*2) TORO MENESES V. (CHI)		3	
9	(*31) CHERNYSHEVA A. (WKF-1)	#131 / 27.11	1	(*21) KODO R. (JPN)
10	(*21) KODO R. (JPN)		3	
11	(*29) ROSENLIND M. (SWE)	#132 / 27.11	1	(*2) TORO MENESES V. (CHI)
12	(*2) TORO MENESES V. (CHI)		3	

1. TORO MENESES VALENTINA (CHI)
2. KODO RINA (JPN)
3. CHERNYSHEVA ANNA (WKF-1)
4. ROSENLIND MATILDA (SWE)

1. YOUSSEF AHLAM (EGY)
2. KVASNICOVA NINA (SVK)
3. ABOURICHE LOUIZA (ALG)
3. TERLIUGA ANZHELIKA (UKR)
5. TORO MENESES VALENTINA (CHI)
5. FURUMOTO-DESHAIES HANA (CAN)
7. SAADATI FATEME (IRI)
7. SADIGOVA MADINA (AZE)

*Seeded

Referees:			



















Female Kumite -55 Kg - Round Robin (each against each)

Karate World Championships - Individual World Championships - Cairo 2025, 3894+XV8, Al Estad, Qesm Than Madinet Nasr, Cairo Governorate 4436020, EGY

Tatami

Pool

5/8

1	 (*14) IZAGUIRRE GALDAMEZ E. (ESA)	#193 / 27.11	3	 (*5) ABOURICHE L. (ALG)
2	 (*5) ABOURICHE L. (ALG)		9	
3	 (*27) WEI Y. (CHN)	#194 / 27.11	9	 (*27) WEI Y. (CHN)
4	 (*8) EL AIDI A. (BEL)		0	
5	 (*5) ABOURICHE L. (ALG)	#197 / 27.11	3	 (*5) ABOURICHE L. (ALG)
6	 (*27) WEI Y. (CHN)		1	
7	 (*14) IZAGUIRRE GALDAMEZ E. (ESA)	#198 / 27.11	7	 (*14) IZAGUIRRE GALDAMEZ E. (ESA)
8	 (*8) EL AIDI A. (BEL)		1	
9	 (*14) IZAGUIRRE GALDAMEZ E. (ESA)	#201 / 27.11	2	 (*14) IZAGUIRRE GALDAMEZ E. (ESA)
10	 (*27) WEI Y. (CHN)		0	
11	 (*5) ABOURICHE L. (ALG)	#202 / 27.11	4	 (*5) ABOURICHE L. (ALG)
12	 (*8) EL AIDI A. (BEL)		2	

1. ABOURICHE LOUIZA (ALG)
2. IZAGUIRRE GALDAMEZ ESTEFANY RACHEL (ESA)
3. WEI YUCHUN (CHN)
4. EL AIDI AYAH (BEL)

1. YOUSSEF AHLAM (EGY)
2. KVASNICOVA NINA (SVK)
3. ABOURICHE LOUIZA (ALG)
3. TERLIUGA ANZHELIKA (UKR)
5. TORO MENESES VALENTINA (CHI)
5. FURUMOTO-DESHAIES HANA (CAN)
7. SAADATI FATEME (IRI)
7. SADIGOVA MADINA (AZE)

*Seeded

Referees:			



















Female Kumite -55 Kg - Round Robin (each against each)

Karate World Championships - Individual World Championships - Cairo 2025, 3894+XV8, Al Estad, Qesm Than Madinet Nasr, Cairo Governorate 4436020, EGY

Tatami

Pool

6/8

1	 (*10) ISHIMWE S. (BDI)	#195 / 27.11	1	 (*30) RAKHIMOVA S. (UZB)
2	 (*30) RAKHIMOVA S. (UZB)	PTS	5	
3	 (*16) STOLI M. (GRE)	#196 / 27.11	3	 (*16) STOLI M. (GRE)
4	 (*4) BITSCH M. (GER)	PTS	1	
5	 (*30) RAKHIMOVA S. (UZB)	#199 / 27.11	6	 (*30) RAKHIMOVA S. (UZB)
6	 (*16) STOLI M. (GRE)	PTS	2	
7	 (*10) ISHIMWE S. (BDI)	#200 / 27.11	0	 (*4) BITSCH M. (GER)
8	 (*4) BITSCH M. (GER)	PTS	10	
9	 (*10) ISHIMWE S. (BDI)	#203 / 27.11	2	 (*16) STOLI M. (GRE)
10	 (*16) STOLI M. (GRE)	PTS	11	
11	 (*30) RAKHIMOVA S. (UZB)	#204 / 27.11	4	 (*30) RAKHIMOVA S. (UZB)
12	 (*4) BITSCH M. (GER)	PTS	1	

1. RAKHIMOVA SEVINCH (UZB)
2. STOLI MARIA (GRE)
3. BITSCH MIA (GER)
4. ISHIMWE SIFA ALICE (BDI)

1. YOUSSEF AHLAM (EGY)
2. KVASNICOVA NINA (SVK)
3. ABOURICHE LOUIZA (ALG)
3. TERLIUGA ANZHELIKA (UKR)
5. TORO MENESES VALENTINA (CHI)
5. FURUMOTO-DESHAIES HANA (CAN)
7. SAADATI FATEME (IRI)
7. SADIGOVA MADINA (AZE)

*Seeded

Referees:			

















Female Kumite -55 Kg - Round Robin (each against each)

Karate World Championships - Individual World Championships - Cairo 2025, 3894+XV8, Al Estad, Qesm Than Madinet Nasr, Cairo Governorate 4436020, EGY

Tatami

Pool

7/8

1	 (*25) ALDRIDGE B. (NZL)	2	 (*17) CEVASCO BARRIENTOS F. (GUA)
	#259 / 27.15		
2	 (*17) CEVASCO BARRIENTOS F. (GUA)	6	
3	 (*9) GORANOVA I. (BUL)	0	
	#260 / 27.11		
4	 (*18) ALISHA A. (IND)	0	
5	 (*17) CEVASCO BARRIENTOS F. (GUA)	0	 (*9) GORANOVA I. (BUL)
	#262 / 27.15		
6	 (*9) GORANOVA I. (BUL)	10	
7	 (*25) ALDRIDGE B. (NZL)	1	 (*18) ALISHA A. (IND)
	#263 / 27.15		
8	 (*18) ALISHA A. (IND)	10	
9	 (*25) ALDRIDGE B. (NZL)	0	 (*9) GORANOVA I. (BUL)
	#265 / 27.15		
10	 (*9) GORANOVA I. (BUL)	7	
11	 (*17) CEVASCO BARRIENTOS F. (GUA)	0	 (*18) ALISHA A. (IND)
	#266 / 27.15		
12	 (*18) ALISHA A. (IND)	4	

1. GORANOVA IVET (BUL)
2. ALISHA ALISHA (IND)
3. CEVASCO BARRIENTOS FABIANA (GUA)
4. ALDRIDGE BRITNEY (NZL)

1. YOUSSEF AHLAM (EGY)
2. KVASNICOVA NINA (SVK)
3. ABOURICHE LOUIZA (ALG)
3. TERLIUGA ANZHELIKA (UKR)
5. TORO MENESES VALENTINA (CHI)
5. FURUMOTO-DESHAIES HANA (CAN)
7. SAADATI FATEME (IRI)
7. SADIGOVA MADINA (AZE)

*Seeded

Referees:			

Female Kumite -55 Kg - Round Robin (each against each)

Karate World Championships - Individual World Championships - Cairo 2025, 3894+XV8, Al Estad, Qesm Than Madinet Nasr, Cairo Governorate 4436020, EGY

Tatami

Pool
8/8

1	(*12) KU T. (TPE)	
	#261 / 27.11	10 (*12) KU T. (TPE)
2	(*23) WARLING J. (LUX)	0
	PTS	
3	(*12) KU T. (TPE)	
	#267 / 27.11	1 (*12) KU T. (TPE)
4	(*1) TERLIUGA A. (UKR)	0
5	(*23) WARLING J. (LUX)	
	#264 / 27.11	0 (*1) TERLIUGA A. (UKR)
6	(*1) TERLIUGA A. (UKR)	7

1. KU TSUI-PING (TPE)
2. TERLIUGA ANZHELIKA (UKR)
3. WARLING JENNIFER (LUX)

1. YOUSSEF AHLAM (EGY)
2. KVASNICOVA NINA (SVK)
3. ABOURICHE LOUIZA (ALG)
3. TERLIUGA ANZHELIKA (UKR)
5. TORO MENESES VALENTINA (CHI)
5. FURUMOTO-DESHAIES HANA (CAN)
7. SAADATI FATEME (IRI)
7. SADIGOVA MADINA (AZE)

*Seeded

Referees:			

Female Kumite -55 Kg

Karate World Championships - Individual World Championships - Cairo 2025

(c)sportdata GmbH & Co KG 2000-2025 (2025-12-02 21:54) v 11.0.0 build 2 (2025-11-22 17:48 CET) License: SDIL TVG ODF (expire 2026-01-23)

Tatami

Pool
1,2,3,4,5,6,7,8

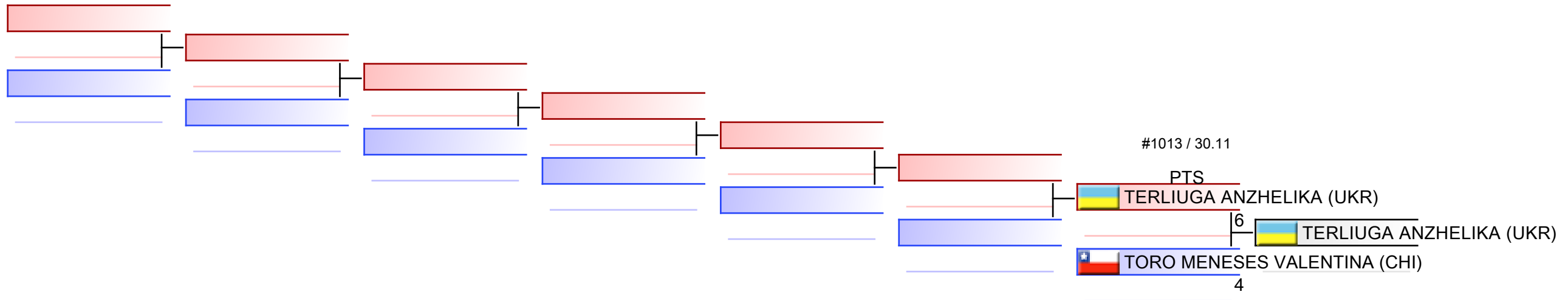

REPECHAGE: (1,2,3,4,5,6,7,8)

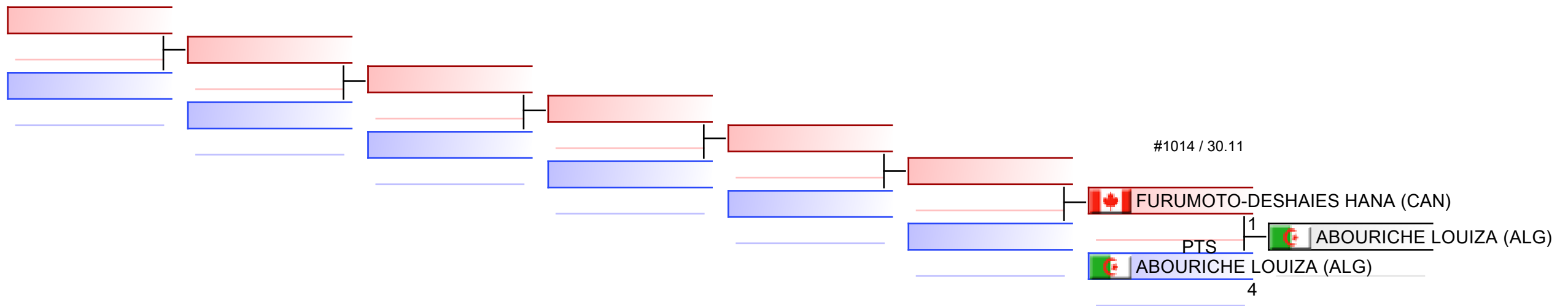

Referees:							
-----------	--	--	--	--	--	--	--



Karate World Championships - Individual World
Championships - Cairo 2025 - 2025-11-27



Official Results

Female Kumite -55 Kg			
1	YOUSSEF AHLAM		EGY - EGYPT
2	KVASNICOVA NINA		SVK - SLOVAKIA
3	ABOURICHE LOUIZA		ALG - ALGERIA
3	TERLIUGA ANZHELIKA		UKR - UKRAINE
5	TORO MENESES VALENTINA		CHI - CHILE
5	FURUMOTO-DESHAIES HANA		CAN - CANADA
7	SAADATI FATEME		IRI - ISLAMIC REPUBLIC OF IRAN
7	SADIGOVA MADINA		AZE - AZERBAIJAN

FEMALE KUMITE -61 KG



Karate World Championships - Individual World Cha ..



ENTRIES BY WEIGHT CATEGORY

Female Kumite -61 Kg

As of 2 DEC 2025

Code	ID	Gender	Name	Seeding
ALG	ALG10418	F	GHELAM KHADIDJA	5
AUS	AUS02484	F	WEBB IRIS	6
AUT	AUT2066	F	TOPALOVIC LEJLA	7
BEL	BEL02934	F	AJARAY MARYAM	8
BIH	BIH2110	F	SIPOVIC EMINA	9
BRA	BRA2042	F	RODRIGUES BARBARA	3
CHI	CHI2361	F	HUAIQUIMAN BARBARA	11
CHN	CHN2139	F	GONG LI	24
CMR	CMR02391	F	NELLY DZEU YOUMBI	10
COL	COL2040	F	BERNAL HERRERA NATALIA	12
ECU	ECU128	F	FACTOS JACQUELINE	13
EGY	EGY2627	F	ALY NOURSIN	14
FRA	FRA02778	F	YVON SYDNEY	15
GER	GER03113	F	KHAMIS REEM	16
IND	IND03857	F	ALI HANEE	17
IRI	IRI02709	F	GOLSHADNEZHAD ATOUSA	4
ITA	ITA03155	F	GRAZIOSI AURORA	18
JPN	JPN02840	F	SHIMADA SARARA	19
KAZ	KAZ2198	F	KANAY ASSEL	1
LAT	LAT02561	F	GIRVICA BEATA	20
MAS	MAS02710	F	ADNAN ZAKIAH	21
NED	NED02396	F	KAKIAY ASHLEY	22
NGR	NGR02405	F	ABODE CONSTANCE TAMUNODIEPREYE	23
POL	POL06896	F	LEWANDOWSKA KATARZYNA	25
ROU	ROU254	F	MALAUTA MIRUNA MIHAELA	26
SUI	SUI2015	F	RADJENOVIC NINA	28
SWE	SWE201	F	NILSSON ANNA-JOHANNA	27
TUN	TUN02329	F	MAHJOUR Wafa	29
TUR	TUR2604	F	YENEN FATMA NAZ	30
UKR	UKR2280	F	SHOLOHOVA OLEKSANDRA	2
UZB	UZB02811	F	OTABOYEVA SEVINCH	31
WKF-2	BLR2087	F	AZARAVA MARYIA	32

Female Kumite -61 Kg - Round Robin (each against each)

Karate World Championships - Individual World Championships - Cairo 2025, 3894+XV8, Al Estad, Qesm Than Madinet Nasr, Cairo Governorate 4436020, EGY

Tatami

Pool

1/8

1	(*12) BERNAL HERRERA N. (COL)	0	(*14) ALY N. (EGY)
	#289 / 28.15		
2	(*14) ALY N. (EGY)	4	
3	(*18) GRAZIOSI A. (ITA)	3	(*22) KAKIAY A. (NED)
	#290 / 28.11		
4	(*22) KAKIAY A. (NED)	3	
	PTS		
5	(*14) ALY N. (EGY)	6	(*14) ALY N. (EGY)
	#293 / 28.11		
6	(*18) GRAZIOSI A. (ITA)	6	
7	(*12) BERNAL HERRERA N. (COL)	0	(*22) KAKIAY A. (NED)
	#294 / 28.15		
8	(*22) KAKIAY A. (NED)	1	
9	(*12) BERNAL HERRERA N. (COL)	1	(*18) GRAZIOSI A. (ITA)
	#297 / 28.15		
10	(*18) GRAZIOSI A. (ITA)	2	
	PTS		
11	(*14) ALY N. (EGY)	1	(*14) ALY N. (EGY)
	#298 / 28.11		
12	(*22) KAKIAY A. (NED)	0	

1. ALY NOURSIN (EGY)
2. KAKIAY ASHLEY (NED)
3. GRAZIOSI AURORA (ITA)
4. BERNAL HERRERA NATALIA (COL)

1. GOLSHADNEZHAD ATOUSA (IRI)
2. GONG LI (CHN)
3. MAHJOUR Wafa (TUN)
3. KANAY ASSEL (KAZ)
5. SHOLOHOVA OLEKSANDRA (UKR)
5. AZARAVA MARYIA (WKF-2)
7. OTABOYEVA SEVINCH (UZB)
7. SHIMADA SARARA (JPN)

*Seeded

Referees:			















Female Kumite -61 Kg - Round Robin (each against each)

Karate World Championships - Individual World Championships - Cairo 2025, 3894+XV8, Al Estad, Qesm Than Madinet Nasr, Cairo Governorate 4436020, EGY

Tatami

Pool

2/8

1	 (*24) GONG L. (CHN)	0
	#291 / 28.11	
2	 (*15) YVON S. (FRA)	0
	PTS	
3	 (*9) SIPOVIC E. (BIH)	4
	#292 / 28.11	 (*9) SIPOVIC E. (BIH)
4	 (*3) RODRIGUES B. (BRA)	3
	PTS	
5	 (*15) YVON S. (FRA)	1
	#295 / 28.11	 (*9) SIPOVIC E. (BIH)
6	 (*9) SIPOVIC E. (BIH)	9
	PTS	
7	 (*24) GONG L. (CHN)	4
	#296 / 28.11	 (*24) GONG L. (CHN)
8	 (*3) RODRIGUES B. (BRA)	0
	PTS	
9	 (*24) GONG L. (CHN)	1
	#299 / 28.11	 (*24) GONG L. (CHN)
10	 (*9) SIPOVIC E. (BIH)	0
	PTS	
11	 (*15) YVON S. (FRA)	0
	#300 / 28.11	 (*3) RODRIGUES B. (BRA)
12	 (*3) RODRIGUES B. (BRA)	2

1. GONG LI (CHN)
2. SIPOVIC EMINA (BIH)
3. RODRIGUES BARBARA (BRA)
4. YVON SYDNEY (FRA)

1. GOLSHADNEZHAD ATOUSA (IRI)
2. GONG LI (CHN)
3. MAHJOUR Wafa (TUN)
3. KANAY ASSEL (KAZ)
5. SHOLOHOVA OLEKSANDRA (UKR)
5. AZARAVA MARYIA (WKF-2)
7. OTABOYEVA SEVINCH (UZB)
7. SHIMADA SARARA (JPN)

*Seeded

Referees:			

Female Kumite -61 Kg - Round Robin (each against each)

Karate World Championships - Individual World Championships - Cairo 2025, 3894+XV8, Al Estad, Qesm Than Madinet Nasr, Cairo Governorate 4436020, EGY

Tatami

Pool
3/8

1	(*5) GHELAM K. (ALG)		(*27) NILSSON A. (SWE)
	#361 / 28.15	0	
2	(*27) NILSSON A. (SWE)		
	PTS	6	
3	(*30) YENEN F. (TUR)		(*30) YENEN F. (TUR)
	#362 / 28.11	6	
4	(*11) HUAIQUIMAN B. (CHI)		
	PTS	5	
5	(*27) NILSSON A. (SWE)		(*30) YENEN F. (TUR)
	#365 / 28.15	0	
6	(*30) YENEN F. (TUR)		
	PTS	2	
7	(*5) GHELAM K. (ALG)		(*5) GHELAM K. (ALG)
	#366 / 28.11	2	
8	(*11) HUAIQUIMAN B. (CHI)		
	PTS	1	
9	(*5) GHELAM K. (ALG)		(*30) YENEN F. (TUR)
	#369 / 28.15	0	
10	(*30) YENEN F. (TUR)		
	PTS	2	
11	(*27) NILSSON A. (SWE)		(*11) HUAIQUIMAN B. (CHI)
	#370 / 28.15	0	
12	(*11) HUAIQUIMAN B. (CHI)		
	PTS	6	

1. YENEN FATMA NAZ (TUR)
2. HUAIQUIMAN BARBARA (CHI)
3. NILSSON ANNA-JOHANNA (SWE)
4. GHELAM KHADIDJA (ALG)

1. GOLSHADNEZHAD ATOUSA (IRI)
2. GONG LI (CHN)
3. MAHJOUR Wafa (TUN)
3. KANAY ASSEL (KAZ)
5. SHOLOHOVA OLEKSANDRA (UKR)
5. AZARAVA MARYIA (WKF-2)
7. OTABOYEVA SEVINCH (UZB)
7. SHIMADA SARARA (JPN)

*Seeded

Referees:			



















Female Kumite -61 Kg - Round Robin (each against each)

Karate World Championships - Individual World Championships - Cairo 2025, 3894+XV8, Al Estad, Qesm Than Madinet Nasr, Cairo Governorate 4436020, EGY

Tatami

Pool

4/8

1	 (*32) AZARAVA M. (WKF-2)	
	#363 / 28.11	6  (*32) AZARAVA M. (WKF-2)
2	 (*23) ABODE C. (NGR)	0
3	 (*25) LEWANDOWSKA K. (POL)	
	#364 / 28.11	1  (*2) SHOLOHOVA O. (UKR)
4	 (*2) SHOLOHOVA O. (UKR)	2
5	 (*23) ABODE C. (NGR)	
	#367 / 28.11	0  (*25) LEWANDOWSKA K. (POL)
6	 (*25) LEWANDOWSKA K. (POL)	2
7	 (*32) AZARAVA M. (WKF-2)	
	#368 / 28.11	0 
8	 (*2) SHOLOHOVA O. (UKR)	0
	PTS	
9	 (*32) AZARAVA M. (WKF-2)	
	#371 / 28.11	1  (*32) AZARAVA M. (WKF-2)
10	 (*25) LEWANDOWSKA K. (POL)	0
11	 (*23) ABODE C. (NGR)	
	#372 / 28.11	1  (*2) SHOLOHOVA O. (UKR)
12	 (*2) SHOLOHOVA O. (UKR)	9

1. SHOLOHOVA OLEKSANDRA (UKR)
2. AZARAVA MARYIA (WKF-2)
3. LEWANDOWSKA KATARZYNA (POL)
4. ABODE CONSTANCE TAMUNODIEPREYE (NGR)

1. GOLSHADNEZHAD ATOUSA (IRI)
2. GONG LI (CHN)
3. MAHJOUR Wafa (TUN)
3. KANAY ASSEL (KAZ)
5. SHOLOHOVA OLEKSANDRA (UKR)
5. AZARAVA MARYIA (WKF-2)
7. OTABOYEVA SEVINCH (UZB)
7. SHIMADA SARARA (JPN)

*Seeded

Referees:			

Female Kumite -61 Kg - Round Robin (each against each)

Karate World Championships - Individual World Championships - Cairo 2025, 3894+XV8, Al Estad, Qesm Than Madinet Nasr, Cairo Governorate 4436020, EGY

Tatami

Pool

5/8

1	(*21) ADNAN Z. (MAS)		
	#430 / 28.11	4	(*21) ADNAN Z. (MAS)
2	(*7) TOPALOVIC L. (AUT)		
	PTS	4	
3	(*6) WEBB I. (AUS)		
	#431 / 28.11	4	(*6) WEBB I. (AUS)
4	(*16) KHAMIS R. (GER)		
	PTS	1	
5	(*7) TOPALOVIC L. (AUT)		
	#434 / 28.11	1	(*6) WEBB I. (AUS)
6	(*6) WEBB I. (AUS)		
	PTS	4	
7	(*21) ADNAN Z. (MAS)		
	#435 / 28.11	3	(*21) ADNAN Z. (MAS)
8	(*16) KHAMIS R. (GER)		
	PTS	1	
9	(*21) ADNAN Z. (MAS)		
	#438 / 28.11	0	(*6) WEBB I. (AUS)
10	(*6) WEBB I. (AUS)		
	PTS	1	
11	(*7) TOPALOVIC L. (AUT)		
	#439 / 28.11	2	(*7) TOPALOVIC L. (AUT)
12	(*16) KHAMIS R. (GER)		
	PTS	0	

1. WEBB IRIS (AUS)
2. ADNAN ZAKIAH (MAS)
3. TOPALOVIC LEJLA (AUT)
4. KHAMIS REEM (GER)

1. GOLSHADNEZHAD ATOUSA (IRI)
2. GONG LI (CHN)
3. MAHJOUR Wafa (TUN)
3. KANAY ASSEL (KAZ)
5. SHOLOHOVA OLEKSANDRA (UKR)
5. AZARAVA MARYIA (WKF-2)
7. OTABOYEVA SEVINCH (UZB)
7. SHIMADA SARARA (JPN)

*Seeded

Referees:			

















Female Kumite -61 Kg - Round Robin (each against each)

Karate World Championships - Individual World Championships - Cairo 2025, 3894+XV8, Al Estad, Qesm Than Madinet Nasr, Cairo Governorate 4436020, EGY

Tatami

Pool

6/8

1	 (*31) OTABOYEVA S. (UZB)	PTS	6	 (*31) OTABOYEVA S. (UZB)
	#432 / 28.11			
2	 (*20) GIRVICA B. (LAT)	3		
3	 (*10) NELLY D. (CMR)	PTS	0	 (*4) GOLSHADNEZHAD A. (IRI)
	#433 / 28.11			
4	 (*4) GOLSHADNEZHAD A. (IRI)	8		
5	 (*20) GIRVICA B. (LAT)	PTS	2	 (*10) NELLY D. (CMR)
	#436 / 28.11			
6	 (*10) NELLY D. (CMR)	5		
7	 (*31) OTABOYEVA S. (UZB)	PTS	1	 (*4) GOLSHADNEZHAD A. (IRI)
	#437 / 28.11			
8	 (*4) GOLSHADNEZHAD A. (IRI)	2		
9	 (*31) OTABOYEVA S. (UZB)	PTS	2	 (*31) OTABOYEVA S. (UZB)
	#440 / 28.11			
10	 (*10) NELLY D. (CMR)	1		
11	 (*20) GIRVICA B. (LAT)	0		
	#441 / 28.11			
12	 (*4) GOLSHADNEZHAD A. (IRI)	0		

1. GOLSHADNEZHAD ATOUSA (IRI)
2. OTABOYEVA SEVINCH (UZB)
3. NELLY DZEU YOUMBI (CMR)
4. GIRVICA BEATA (LAT)

1. GOLSHADNEZHAD ATOUSA (IRI)
2. GONG LI (CHN)
3. MAHJOUR Wafa (TUN)
3. KANAY ASSEL (KAZ)
5. SHOLOHOVA OLEKSANDRA (UKR)
5. AZARAVA MARYIA (WKF-2)
7. OTABOYEVA SEVINCH (UZB)
7. SHIMADA SARARA (JPN)

*Seeded

Referees:			

Female Kumite -61 Kg - Round Robin (each against each)

Karate World Championships - Individual World Championships - Cairo 2025, 3894+XV8, Al Estad, Qesm Than Madinet Nasr, Cairo Governorate 4436020, EGY

Tatami

Pool

7/8

1	(*19) SHIMADA S. (JPN)		
	#499 / 28.11	4	(*19) SHIMADA S. (JPN)
2	(*13) FACTOS J. (ECU)	0	
	PTS		
3	(*8) AJARAY M. (BEL)		
	#500 / 28.11	2	(*8) AJARAY M. (BEL)
4	(*26) MALAUTA M. (ROU)	1	
5	(*13) FACTOS J. (ECU)	0	
	#503 / 28.11	0	(*8) AJARAY M. (BEL)
6	(*8) AJARAY M. (BEL)	7	
	PTS		
7	(*19) SHIMADA S. (JPN)		
	#504 / 28.11	2	(*19) SHIMADA S. (JPN)
8	(*26) MALAUTA M. (ROU)	0	
	PTS		
9	(*19) SHIMADA S. (JPN)		
	#507 / 28.11	4	(*19) SHIMADA S. (JPN)
10	(*8) AJARAY M. (BEL)	2	
11	(*13) FACTOS J. (ECU)	2	
	#508 / 28.11	2	(*26) MALAUTA M. (ROU)
12	(*26) MALAUTA M. (ROU)	2	

1. SHIMADA SARARA (JPN)
2. AJARAY MARYAM (BEL)
3. MALAUTA MIRUNA MIHAELA (ROU)
4. FACTOS JACQUELINE (ECU)

1. GOLSHADNEZHAD ATOUSA (IRI)
2. GONG LI (CHN)
3. MAHJOUR Wafa (TUN)
3. KANAY ASSEL (KAZ)
5. SHOLOHOVA OLEKSANDRA (UKR)
5. AZARAVA MARYIA (WKF-2)
7. OTABOYEVA SEVINCH (UZB)
7. SHIMADA SARARA (JPN)

*Seeded

Referees:			

Female Kumite -61 Kg - Round Robin (each against each)

Karate World Championships - Individual World Championships - Cairo 2025, 3894+XV8, Al Estad, Qesm Than Madinet Nasr, Cairo Governorate 4436020, EGY

Tatami

Pool
8/8

1	(*17) ALI H. (IND)	#501 / 28.15	3	(*28) RADJENOVIC N. (SUI)
2	(*28) RADJENOVIC N. (SUI)	5		
3	(*29) MAHJOUB W. (TUN)	PTS		
3	#502 / 28.11	2	(*29) MAHJOUB W. (TUN)	
4	(*1) KANAY A. (KAZ)	1		
5	(*28) RADJENOVIC N. (SUI)	#505 / 28.15	0	(*29) MAHJOUB W. (TUN)
6	(*29) MAHJOUB W. (TUN)	4		
7	(*17) ALI H. (IND)	#506 / 28.15	0	(*1) KANAY A. (KAZ)
8	(*1) KANAY A. (KAZ)	8		
9	(*17) ALI H. (IND)	#509 / 28.15	0	(*29) MAHJOUB W. (TUN)
10	(*29) MAHJOUB W. (TUN)	9		
11	(*28) RADJENOVIC N. (SUI)	#510 / 28.15	1	(*1) KANAY A. (KAZ)
12	(*1) KANAY A. (KAZ)	3		

1. MAHJOUB Wafa (TUN)
2. KANAY ASSEL (KAZ)
3. RADJENOVIC NINA (SUI)
4. ALI HANEE (IND)

1. GOLSHADNEZHAD ATOUSA (IRI)
2. GONG LI (CHN)
3. MAHJOUB Wafa (TUN)
3. KANAY ASSEL (KAZ)
5. SHOLOHOVA OLEKSANDRA (UKR)
5. AZARAVA MARYIA (WKF-2)
7. OTABOYEVA SEVINCH (UZB)
7. SHIMADA SARARA (JPN)

*Seeded

Referees:			

Pool winner-Female Kumite -61 Kg

Karate World Championships - Individual World Championships - Cairo 2025, 3894+XV8, Al Estad, Qesm Than Madinet Nasr, Cairo Governorate 4436020, EGY

Tatami

Pool

1/1

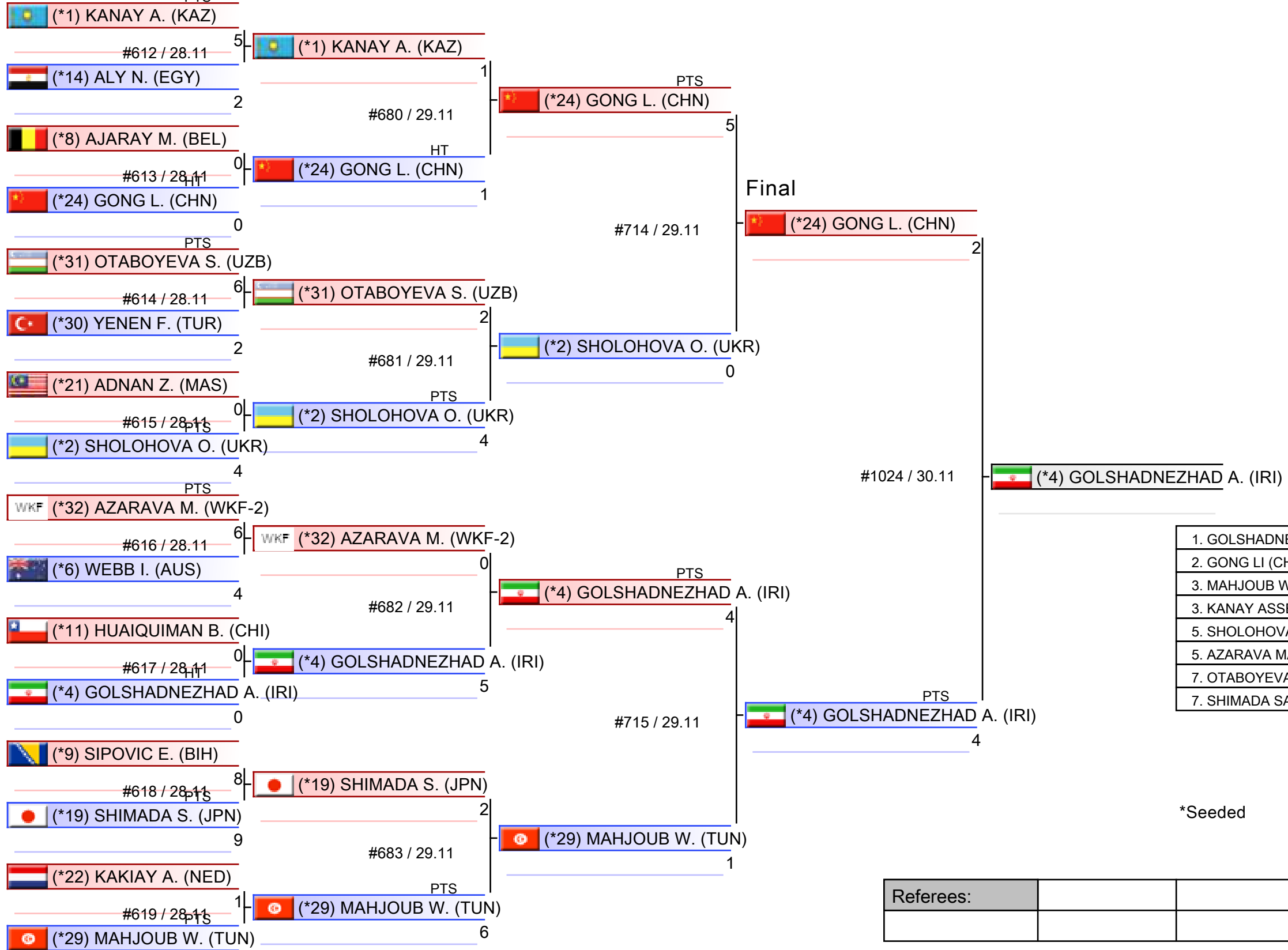

1. GOLSHADNEZHAD ATOUSA (IRI)
2. GONG LI (CHN)
3. MAHJOUR Wafa (TUN)
3. KANAY ASSEL (KAZ)
5. SHOLOHOVA OLEKSANDRA (UKR)
5. AZARAVA MARYIA (WKF-2)
7. OTABOYEVA SEVINCH (UZB)
7. SHIMADA SARARA (JPN)

*Seeded

Referees:			

Female Kumite -61 Kg

Karate World Championships - Individual World Championships - Cairo 2025

(c)sportdata GmbH & Co KG 2000-2025 (2025-12-02 21:54) v 11.0.0 build 2 (2025-11-22 17:48 CET) License: SDIL TVG ODF (expire 2026-01-23)

Tatami

Pool
1,2,3,4,5,6,7,8

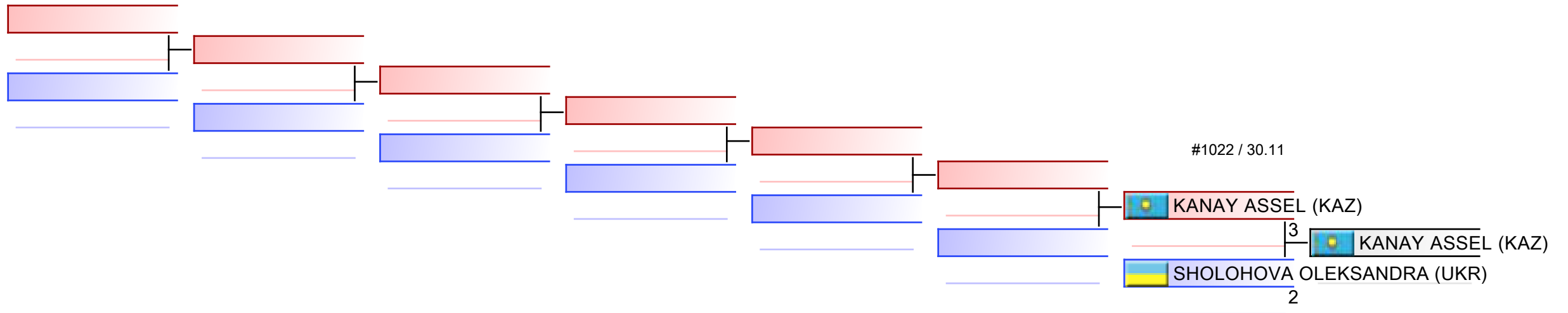

REPECHAGE: (1,2,3,4,5,6,7,8)

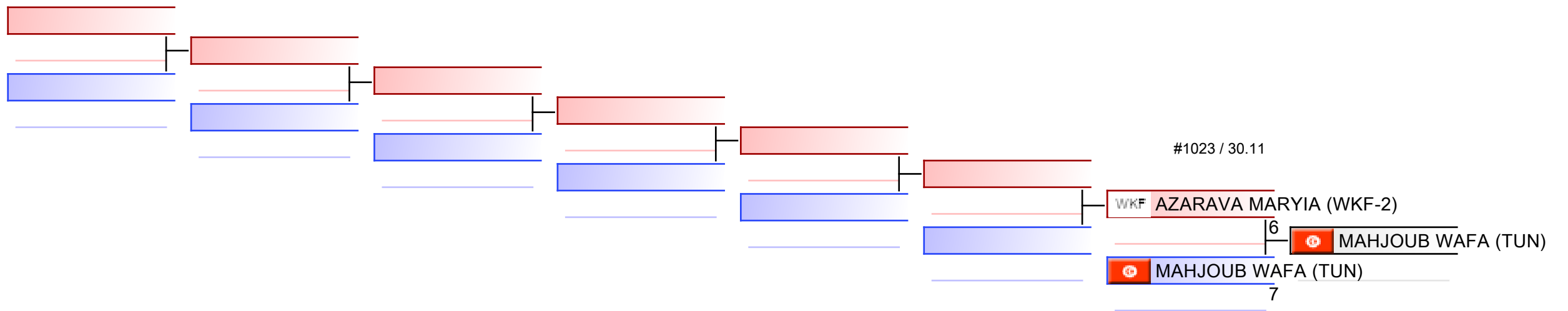

Referees:							
-----------	--	--	--	--	--	--	--



Karate World Championships - Individual World
Championships - Cairo 2025 - 2025-11-27



Official Results

Female Kumite -61 Kg			
1	GOLSHADNEZHAD ATOUSA		IRI - ISLAMIC REPUBLIC OF IRAN
2	GONG LI		CHN - PEOPLES REPUBLIC OF CHINA
3	MAHJOUR WAFI		TUN - TUNISIA
3	KANAY ASSEL		KAZ - KAZAKHSTAN
5	SHOLOHOVA OLEKSANDRA		UKR - UKRAINE
5	AZARAVA MARYIA		WKF-2 - WKF-2
7	OTABOYEVA SEVINCH		UZB - UZBEKISTAN
7	SHIMADA SARARA		JPN - JAPAN

FEMALE KUMITE -68 KG



Karate World Championships - Individual World Cha ..



ENTRIES BY WEIGHT CATEGORY

Female Kumite -68 Kg

As of 2 DEC 2025

Code	ID	Gender	Name	Seeding
ALG	ALG02881	F	MEKKAOUI KARIMA	5
AUS	AUS003077	F	GOLDING LAURA	6
AUT	AUT2234	F	DEVIGILI HANNA	7
AZE	AZE2043	F	ZARETSKA IRYNA	1
CHI	CHI03118	F	VELOZO ANASTASIIA	9
CMR	CMR02581	F	OLIVIA DAVINA BODIONG GABOAYA	8
CRO	CRO2104	F	BECIROVIC SADEA	10
EGY	EGY2194	F	HENDY HADIR	11
ESP	ESP2359	F	NIETO MEJIAS MARIA ISABEL	27
FRA	FRA02723	F	SOMBE THALYA	4
GER	GER02746	F	RIEDEL HANNAH	12
GUA	GUA2027	F	PALENCIA LUISA	13
GUI	GUI002591	F	KEITA ANNE-CORALIE TYPHAINE	
HKG	HKG2148	F	WONG CHEUK LEE	14
IND	IND03020	F	JADHAV BHUVANESHWARI SURESH	15
IRI	IRI2132	F	HEYDARIOZOMCHELOE MOBINA	16
ITA	ITA377	F	SEMERARO SILVIA	17
JPN	JPN03040	F	KAMA TSUBASA	3
KAZ	KAZ02709	F	DARENKAYA DAIYANA	18
KOS	KOS2382	F	QERIMI VLERA	19
MAR	MAR2238	F	BROUK NISRINE	20
MKD	MKD369	F	MOJSOVSKA ANGELA	23
NED	NED2016	F	SNEL LYNN	21
NZL	NZL2113	F	MCLACHLAN JULIET	22
PUR	PUR2007	F	FONSECA ROMERO JANESSA MICHELLE	24
RSA	RSA02619	F	LUFF CARLA	26
SUI	SUI202	F	QUIRICI ELENA	2
SVK	SVK2193	F	KRIVDOVA SARA	25
TUR	TUR786	F	ELTEMUR EDA	28
UKR	UKR2373	F	SIELIEMIENIEVA ELINA	29
USA	USA2328	F	LINGL SKYLAR	30

Female Kumite -68 Kg - Round Robin (each against each)

Karate World Championships - Individual World Championships - Cairo 2025, 3894+XV8, Al Estad, Qesm Than Madinet Nasr, Cairo Governorate 4436020, EGY

Tatami

Pool

1/8

1	(*7) DEVIGILI H. (AUT)	#313 / 28.11	
2	(*5) MEKKAOUI K. (ALG)		
3	(*16) HEYDARIOZOMCHELOE M. (IRI)	#314 / 28.11	1 (*24) FONSECA ROMERO J. (PUR)
4	(*24) FONSECA ROMERO J. (PUR)		1
5	(*5) MEKKAOUI K. (ALG)	#317 / 28.11	
6	(*16) HEYDARIOZOMCHELOE M. (IRI)		
7	(*7) DEVIGILI H. (AUT)	#318 / 28.11	1 (*24) FONSECA ROMERO J. (PUR)
8	(*24) FONSECA ROMERO J. (PUR)		3
9	(*7) DEVIGILI H. (AUT)	#321 / 28.11	2 (*7) DEVIGILI H. (AUT)
10	(*16) HEYDARIOZOMCHELOE M. (IRI)		1
11	(*5) MEKKAOUI K. (ALG)	#322 / 28.11	
12	(*24) FONSECA ROMERO J. (PUR)		

1. FONSECA ROMERO JANESEA MICHELLE (PUR)
2. DEVIGILI HANNA (AUT)
3. HEYDARIOZOMCHELOE MOBINA (IRI)
4. MEKKAOUI KARIMA (ALG)

1. SOMBE THALYA (FRA)
2. FONSECA ROMERO JANESEA MICHELLE (PUR)
3. VELOZO ANASTASIIA (CHI)
3. ZARETSKA IRYNA (AZE)
5. QUIRICI ELENA (SUI)
5. SEMERARO SILVIA (ITA)
7. DARENSKAYA DAIYANA (KAZ)
7. HENDY HADIR (EGY)

*Seeded

Referees:			

Female Kumite -68 Kg - Round Robin (each against each)

Karate World Championships - Individual World Championships - Cairo 2025, 3894+XV8, Al Estad, Qesm Than Madinet Nasr, Cairo Governorate 4436020, EGY

Tatami

Pool
2/8

1	(*9) VELOZO A. (CHI)	#315 / 28.11	0	(*19) QERIMI V. (KOS)
2	(*19) QERIMI V. (KOS)		3	
3	(*26) LUFF C. (RSA)	#316 / 28.11	1	(*3) KAMA T. (JPN)
4	(*3) KAMA T. (JPN)		5	
5	(*19) QERIMI V. (KOS)	PTS		
6	(*26) LUFF C. (RSA)	#319 / 28.11	9	(*19) QERIMI V. (KOS)
7	(*9) VELOZO A. (CHI)	PTS		
8	(*3) KAMA T. (JPN)	#320 / 28.11	6	(*9) VELOZO A. (CHI)
9	(*9) VELOZO A. (CHI)	PTS		
10	(*26) LUFF C. (RSA)	#323 / 28.11	11	(*9) VELOZO A. (CHI)
11	(*19) QERIMI V. (KOS)		3	
12	(*3) KAMA T. (JPN)	#324 / 28.11	0	(*3) KAMA T. (JPN)
			6	

1. VELOZO ANASTASIIA (CHI)
2. KAMA TSUBASA (JPN)
3. QERIMI VLERA (KOS)
4. LUFF CARLA (RSA)

1. SOMBE THALYA (FRA)
2. FONSECA ROMERO JANESEA MICHELLE (PUR)
3. VELOZO ANASTASIIA (CHI)
3. ZARETSKA IRYNA (AZE)
5. QUIRICI ELENA (SUI)
5. SEMERARO SILVIA (ITA)
7. DARENSKAYA DAIYANA (KAZ)
7. HENDY HADIR (EGY)

*Seeded

Referees:			

Female Kumite -68 Kg - Round Robin (each against each)

Karate World Championships - Individual World Championships - Cairo 2025, 3894+XV8, Al Estad, Qesm Than Madinet Nasr, Cairo Governorate 4436020, EGY

Tatami

Pool

3/8

1	(*20) BROUK N. (MAR)	#385 / 28.11	6	(*20) BROUK N. (MAR)
2	(*22) MCLACHLAN J. (NZL)		2	
3	(*10) BECIROVIC S. (CRO)	#386 / 28.11	0	(*12) RIEDEL H. (GER)
4	(*12) RIEDEL H. (GER)		1	
5	(*22) MCLACHLAN J. (NZL)	#388 / 28.11	0	(*10) BECIROVIC S. (CRO)
6	(*10) BECIROVIC S. (CRO)		3	
7	(*20) BROUK N. (MAR)	#389 / 28.11	0	(*12) RIEDEL H. (GER)
8	(*12) RIEDEL H. (GER)		1	
9	(*20) BROUK N. (MAR)	#391 / 28.11	1	(*10) BECIROVIC S. (CRO)
10	(*10) BECIROVIC S. (CRO)		2	
11	(*22) MCLACHLAN J. (NZL)	#392 / 28.11	0	(*12) RIEDEL H. (GER)
12	(*12) RIEDEL H. (GER)		8	

1. RIEDEL HANNAH (GER)
2. BECIROVIC SADEA (CRO)
3. BROUK NISRINE (MAR)
4. MCLACHLAN JULIET (NZL)

1. SOMBE THALYA (FRA)
2. FONSECA ROMERO JANESSA MICHELLE (PUR)
3. VELOZO ANASTASIIA (CHI)
3. ZARETSKA IRYNA (AZE)
5. QUIRICI ELENA (SUI)
5. SEMERARO SILVIA (ITA)
7. DARENSKAYA DAIYANA (KAZ)
7. HENDY HADIR (EGY)

*Seeded

Referees:			



















Female Kumite -68 Kg - Round Robin (each against each)

Karate World Championships - Individual World Championships - Cairo 2025, 3894+XV8, Al Estad, Qesm Than Madinet Nasr, Cairo Governorate 4436020, EGY

Tatami

Pool

4/8

1	 KEITA A. (GUI)	#800 / 28.11	4	 KEITA A. (GUI)
2	 (*15) JADHAV B. (IND)		0	
3	 (*27) NIETO MEJIAS M. (ESP)	#801 / 28.11	0	 (*2) QUIRICI E. (SUI)
4	 (*2) QUIRICI E. (SUI)		2	
5	 (*15) JADHAV B. (IND)	#802 / 28.11	1	 (*27) NIETO MEJIAS M. (ESP)
6	 (*27) NIETO MEJIAS M. (ESP)		4	
7	 KEITA A. (GUI)	#803 / 28.11	0	 (*2) QUIRICI E. (SUI)
8	 (*2) QUIRICI E. (SUI)		1	
9	 KEITA A. (GUI)	#804 / 28.11	6	 KEITA A. (GUI)
10	 (*27) NIETO MEJIAS M. (ESP)		3	
11	 (*15) JADHAV B. (IND)	#805 / 28.11	0	 (*2) QUIRICI E. (SUI)
12	 (*2) QUIRICI E. (SUI)		4	

1. QUIRICI ELENA (SUI)
2. KEITA ANNE-CORALIE TYPHAINE (GUI)
3. NIETO MEJIAS MARIA ISABEL (ESP)
4. JADHAV BHUVANESHWARI SURESH (IND)

1. SOMBE THALYA (FRA)
2. FONSECA ROMERO JANESSA MICHELLE (PUR)
3. VELOZO ANASTASIIA (CHI)
3. ZARETSKA IRYNA (AZE)
5. QUIRICI ELENA (SUI)
5. SEMERARO SILVIA (ITA)
7. DARENSKAYA DAIYANA (KAZ)
7. HENDY HADIR (EGY)

*Seeded

Referees:			

Female Kumite -68 Kg - Round Robin (each against each)

Karate World Championships - Individual World Championships - Cairo 2025, 3894+XV8, Al Estad, Qesm Than Madinet Nasr, Cairo Governorate 4436020, EGY

Tatami

Pool
5/8

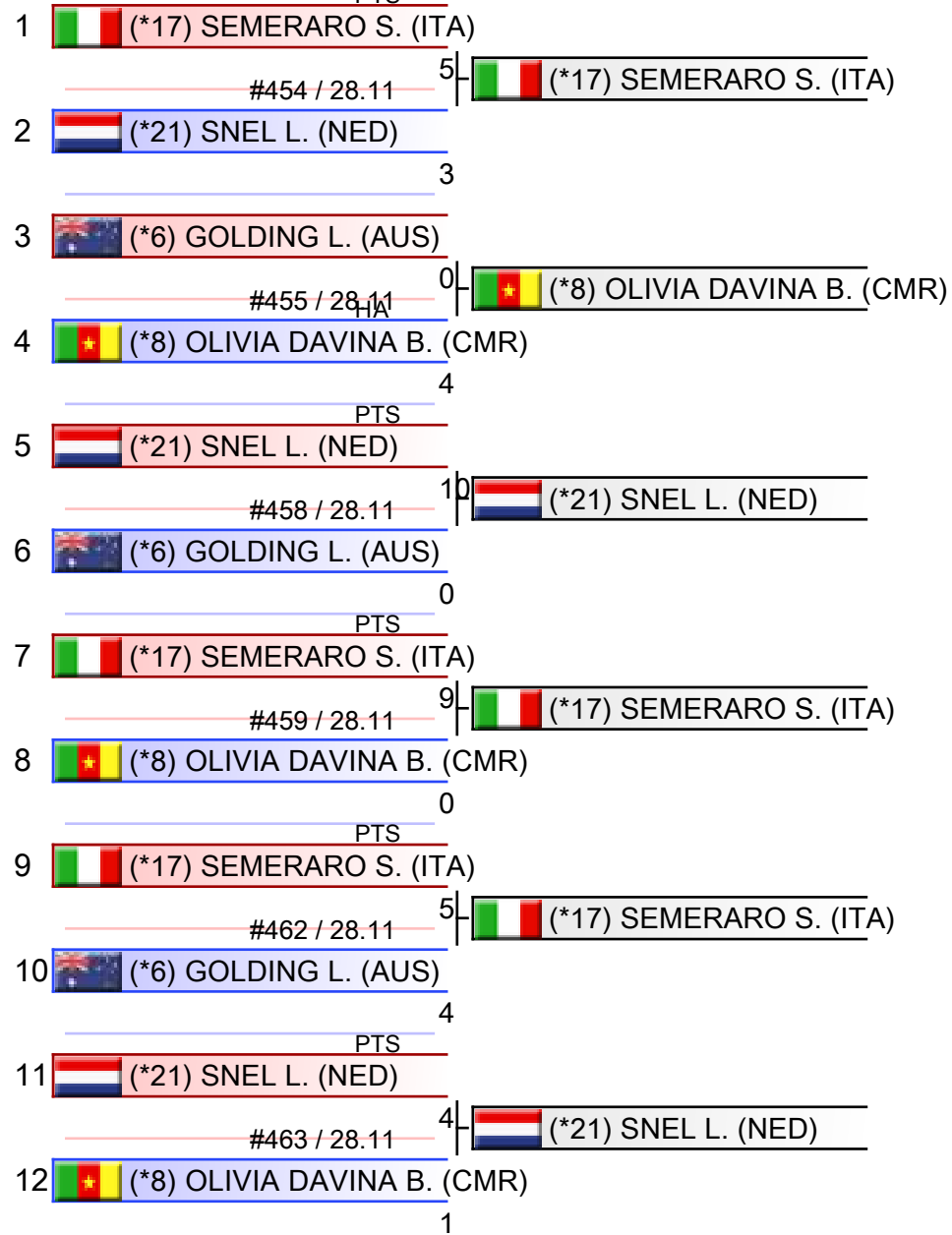

1. SEMERARO SILVIA (ITA)
2. SNEL LYNN (NED)
3. OLIVIA DAVINA BODIONG GABOAYA (CMR)
4. GOLDING LAURA (AUS)

1. SOMBE THALYA (FRA)
2. FONSECA ROMERO JANESSA MICHELLE (PUR)
3. VELOZO ANASTASIIA (CHI)
3. ZARETSKA IRYNA (AZE)
5. QUIRICI ELENA (SUI)
5. SEMERARO SILVIA (ITA)
7. DARENSKAYA DAIYANA (KAZ)
7. HENDY HADIR (EGY)

*Seeded

Referees:			

Female Kumite -68 Kg - Round Robin (each against each)

Karate World Championships - Individual World Championships - Cairo 2025, 3894+XV8, Al Estad, Qesm Than Madinet Nasr, Cairo Governorate 4436020, EGY

Tatami

Pool
6/8

1	(*28) ELTEMUR E. (TUR)	
	#456 / 28.11	3 (*13) PALENCIA L. (GUA)
2	(*13) PALENCIA L. (GUA)	5
3	(*18) DARENSKAYA D. (KAZ)	
	#457 / 28.11	5
4	(*4) SOMBE T. (FRA)	5
5	(*13) PALENCIA L. (GUA)	
	#460 / 28.11	0 (*18) DARENSKAYA D. (KAZ)
6	(*18) DARENSKAYA D. (KAZ)	2
7	(*28) ELTEMUR E. (TUR)	
	#461 / 28.11	0 (*4) SOMBE T. (FRA)
8	(*4) SOMBE T. (FRA)	1
	HA	
9	(*28) ELTEMUR E. (TUR)	
	#464 / 28.11	4 (*28) ELTEMUR E. (TUR)
10	(*18) DARENSKAYA D. (KAZ)	0
11	(*13) PALENCIA L. (GUA)	
	#465 / 28.11	1 (*4) SOMBE T. (FRA)
12	(*4) SOMBE T. (FRA)	2

1. SOMBE THALYA (FRA)
2. DARENSKAYA DAIYANA (KAZ)
3. PALENCIA LUISA (GUA)
4. ELTEMUR EDA (TUR)

1. SOMBE THALYA (FRA)
2. FONSECA ROMERO JANESEA MICHELLE (PUR)
3. VELOZO ANASTASIIA (CHI)
3. ZARETSKA IRYNA (AZE)
5. QUIRICI ELENA (SUI)
5. SEMERARO SILVIA (ITA)
7. DARENSKAYA DAIYANA (KAZ)
7. HENDY HADIR (EGY)

*Seeded

Referees:			

















Female Kumite -68 Kg - Round Robin (each against each)

Karate World Championships - Individual World Championships - Cairo 2025, 3894+XV8, Al Estad, Qesm Than Madinet Nasr, Cairo Governorate 4436020, EGY

Tatami

Pool

7/8

1	 (*23) MOJSOVSKA A. (MKD)	#523 / 28.11	3	 (*23) MOJSOVSKA A. (MKD)
2	 (*30) LINGL S. (USA)		2	
3	 (*29) SIELIEMIENIEVA E. (UKR)	#524 / 28.11	1	
4	 (*11) HENDY H. (EGY)		1	
5	 (*30) LINGL S. (USA)	#526 / 28.11	0	 (*29) SIELIEMIENIEVA E. (UKR)
6	 (*29) SIELIEMIENIEVA E. (UKR)		4	
7	 (*23) MOJSOVSKA A. (MKD)	#527 / 28.11	0	 (*11) HENDY H. (EGY)
8	 (*11) HENDY H. (EGY)		10	
9	 (*23) MOJSOVSKA A. (MKD)	HA	5	 (*23) MOJSOVSKA A. (MKD)
10	 (*29) SIELIEMIENIEVA E. (UKR)	#529 / 28.11	4	
11	 (*30) LINGL S. (USA)		3	 (*11) HENDY H. (EGY)
12	 (*11) HENDY H. (EGY)	#530 / 28.11	4	

1. HENDY HADIR (EGY)
2. MOJSOVSKA ANGELA (MKD)
3. SIELIEMIENIEVA ELINA (UKR)
4. LINGL SKYLAR (USA)

1. SOMBE THALYA (FRA)
2. FONSECA ROMERO JANESSA MICHELLE (PUR)
3. VELOZO ANASTASIIA (CHI)
3. ZARETSKA IRYNA (AZE)
5. QUIRICI ELENA (SUI)
5. SEMERARO SILVIA (ITA)
7. DARENSKAYA DAIYANA (KAZ)
7. HENDY HADIR (EGY)

*Seeded

Referees:			

Female Kumite -68 Kg - Round Robin (each against each)

Karate World Championships - Individual World Championships - Cairo 2025, 3894+XV8, Al Estad, Qesm Than Madinet Nasr, Cairo Governorate 4436020, EGY

Tatami

Pool
8/8

1	(*25) KRIVDOVA S. (SVK)	2	(*25) KRIVDOVA S. (SVK)
	#525 / 28.11		
2	(*14) WONG C. (HKG)	3	(*25) KRIVDOVA S. (SVK)
	0		
3	(*25) KRIVDOVA S. (SVK)	4	(*1) ZARETSKA I. (AZE)
	#531 / 28.11		
4	(*1) ZARETSKA I. (AZE)	5	(*14) WONG C. (HKG)
	5		
5	(*14) WONG C. (HKG)	6	(*1) ZARETSKA I. (AZE)
	#528 / 28.11		
6	(*1) ZARETSKA I. (AZE)		7

1. ZARETSKA IRYNA (AZE)
2. KRIVDOVA SARA (SVK)
3. WONG CHEUK LEE (HKG)

1. SOMBE THALYA (FRA)
2. FONSECA ROMERO JANESEA MICHELLE (PUR)
3. VELOZO ANASTASIIA (CHI)
3. ZARETSKA IRYNA (AZE)
5. QUIRICI ELENA (SUI)
5. SEMERARO SILVIA (ITA)
7. DARENSKAYA DAIYANA (KAZ)
7. HENDY HADIR (EGY)

*Seeded

Referees:			

Pool winner-Female Kumite -68 Kg

Karate World Championships - Individual World Championships - Cairo 2025, 3894+XV8, Al Estad, Qesm Than Madinet Nasr, Cairo Governorate 4436020, EGY

Tatami Pool 1/1

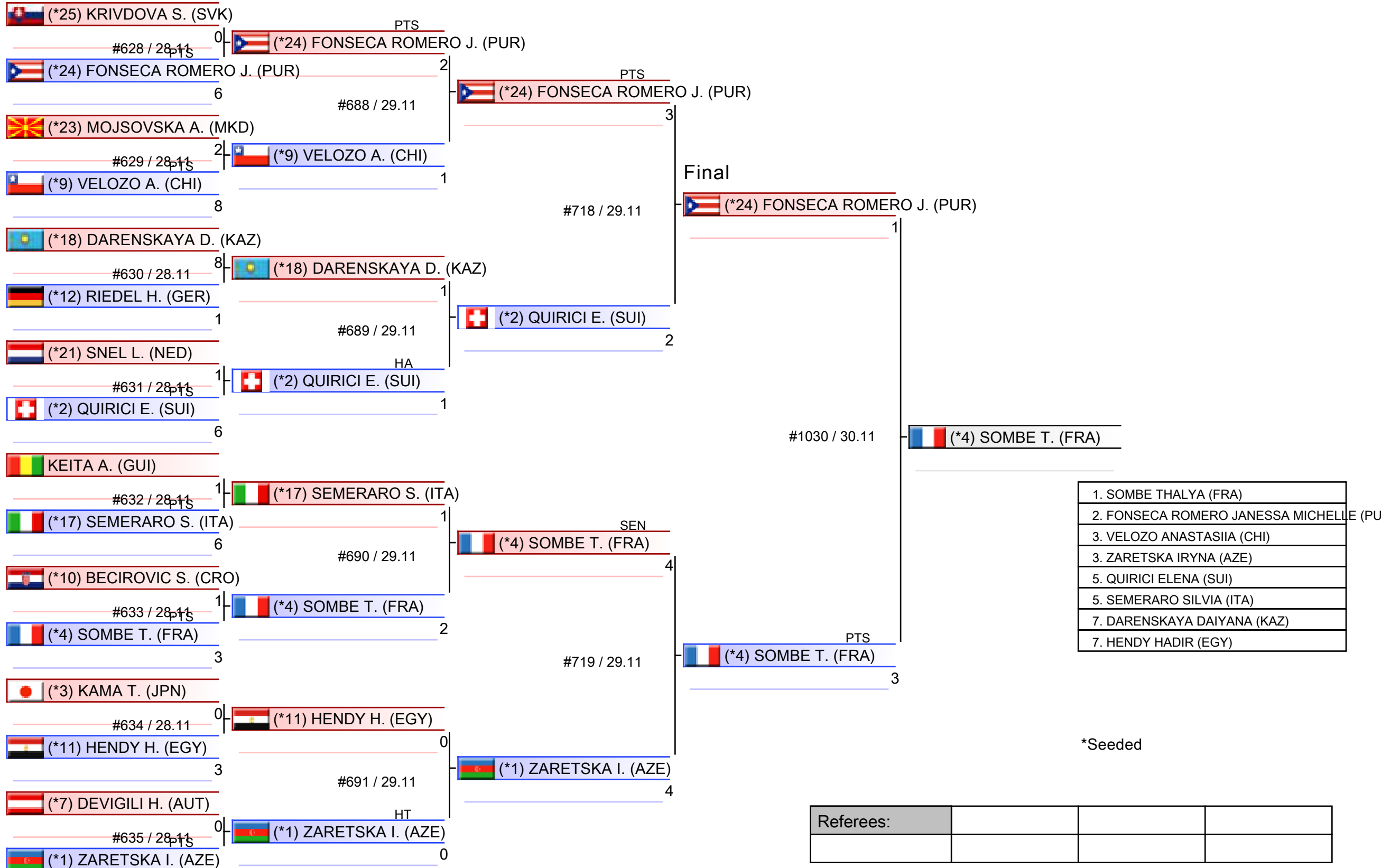

Female Kumite -68 Kg

Karate World Championships - Individual World Championships - Cairo 2025

Tatami

Pool

1,2,3,4,5,6,7,8

(c)sportdata GmbH & Co KG 2000-2025 (2025-12-02 21:54) v 11.0.0 build 2 (2025-11-22 17:48 CET) License: SDIL TVG ODF (expire 2026-01-23)

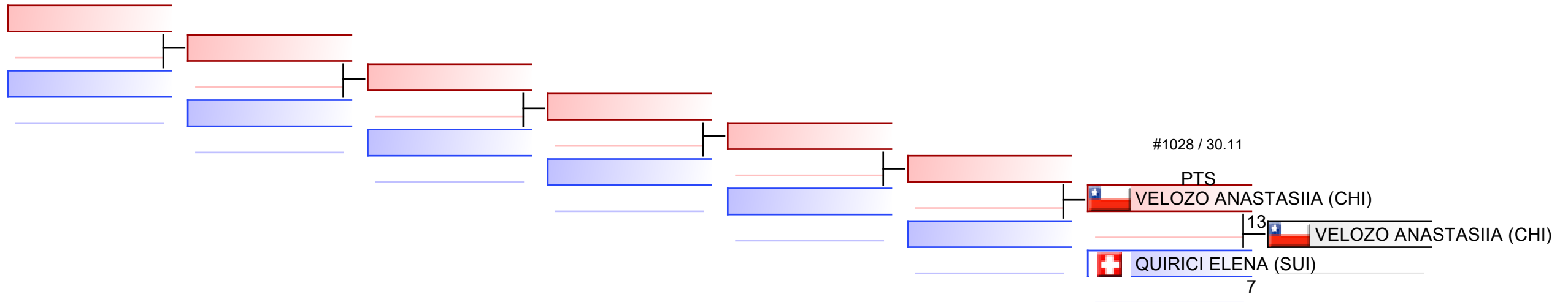

REPECHAGE: (1,2,3,4,5,6,7,8)

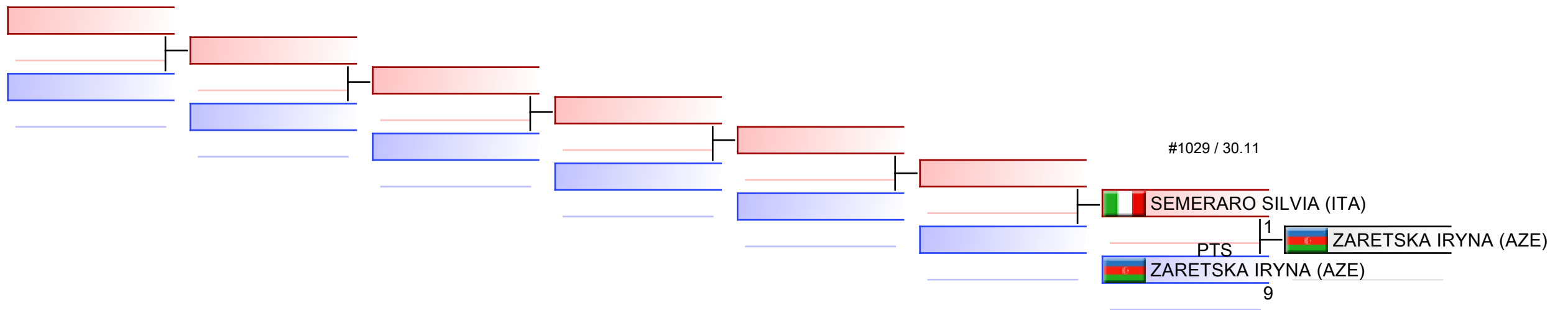

Referees:							
-----------	--	--	--	--	--	--	--



Karate World Championships - Individual World Championships - Cairo 2025 - 2025-11-27



Official Results

Female Kumite -68 Kg			
1	SOMBE THALYA		FRA - FRANCE
2	FONSECA ROMERO JANELSA MICHELLE		PUR - PUERTO RICO
3	VELOZO ANASTASIIA		CHI - CHILE
3	ZARETSKA IRYNA		AZE - AZERBAIJAN
5	QUIRICI ELENA		SUI - SWITZERLAND
5	SEMERARO SILVIA		ITA - ITALY
7	DARENKAYA DAIYANA		KAZ - KAZAKHSTAN
7	HENDY HADIR		EGY - EGYPT

FEMALE KUMITE 68+ KG



Karate World Championships - Individual World Cha ..



ENTRIES BY WEIGHT CATEGORY

Female Kumite 68+ Kg

As of 2 DEC 2025

Code	ID	Gender	Name	Seeding
ALG	ALG2482	F	OUDIRA CHAIMA	5
AUS	AUS02700	F	BOYCE KRYSTAL	6
AUT	AUT2015	F	ZILLER LORA	7
BEL	BEL2219	F	MULOLO OPHELIE	8
BRA	BRA2044	F	PEREIRA BRENDA	9
CHI	CHI129	F	GONZALEZ LAVIN JAVIERA	10
CRO	CRO2457	F	GOLOMBOS NIKOLINA	11
DOM	DOM2022	F	RODRIGUEZ OGANDO PAMELA	12
EGY	EGY2525	F	OKILA MENNA SHAABAN	13
ENG	ENG2406	F	WALTERS ROCHELLE	14
ESP	ESP2007	F	TORRES GARCIA MARIA	1
FRA	FRA372	F	GARCIA NANCY	15
GER	GER2090	F	KNEER JOHANNA	3
GRE	GRE565	F	KYDONAKI KYRIAKI	4
HUN	HUN02677	F	FLEISCHER DORA	16
ITA	ITA570	F	FERRACUTI CLIO	17
JOR	JOR02537	F	NASER YARA	19
JPN	JPN03367	F	SUGITA SUMIRE	18
KAZ	KAZ2140	F	BERULTSEVA SOFYA	2
MEX	MEX274	F	QUINTAL CATZIN GUADALUPE	20
NED	NED221	F	CREEMERS INGRID	22
NEP	NEP003158	F	GURUNG ARIKA	21
NGR	NGR2030	F	NWANKWO UJUNWA CAROLINE	23
POL	POL4033	F	DANISZEWSKA JULIA	24
POR	POR251	F	OLIVEIRA ANA RITA	25
ROU	ROU2185	F	COMAN MARIA CRISTINA	26
SCO	SCO2098	F	JUNNER NIAMH	27
SWE	SWE02480	F	BAO BEDNARSKI SOPHIE	28
TUN	TUN02580	F	BEN TAIEB ISRA	29
TUR	TUR308	F	HOCAOGLU AKYOL MELTEM	30
UKR	UKR02864	F	BULAY DARIIA	31
UZB	UZB02442	F	KHAKIMJONOVA MOKHLAROYIM	32

Female Kumite 68+ Kg - Round Robin (each against each)

Karate World Championships - Individual World Championships - Cairo 2025, 3894+XV8, Al Estad, Qesm Than Madinet Nasr, Cairo Governorate 4436020, EGY

Tatami

Pool

1/8

1	 (*23) NWANKWO U. (NGR)	1	 (*20) QUINTAL CATZIN G. (MEX)
	#337 / 28.15		
2	 (*20) QUINTAL CATZIN G. (MEX)	6	
3	 (*30) HOCAOGLU AKYOL M. (TUR)	0	 (*14) WALTERS R. (ENG)
	#338 / 28.15		
4	 (*14) WALTERS R. (ENG)	4	
	PTS		
5	 (*20) QUINTAL CATZIN G. (MEX)	5	 (*20) QUINTAL CATZIN G. (MEX)
	#341 / 28.11		
6	 (*30) HOCAOGLU AKYOL M. (TUR)	4	
7	 (*23) NWANKWO U. (NGR)	1	 (*14) WALTERS R. (ENG)
	#342 / 28.15		
8	 (*14) WALTERS R. (ENG)	6	
9	 (*23) NWANKWO U. (NGR)	0	 (*30) HOCAOGLU AKYOL M. (TUR)
	#345 / 28.15		
10	 (*30) HOCAOGLU AKYOL M. (TUR)	3	
11	 (*20) QUINTAL CATZIN G. (MEX)	1	 (*14) WALTERS R. (ENG)
	#346 / 28.15		
12	 (*14) WALTERS R. (ENG)	4	

1. WALTERS ROCHELLE (ENG)
2. QUINTAL CATZIN GUADALUPE (MEX)
3. HOCAOGLU AKYOL MELTEM (TUR)
4. NWANKWO UJUNWA CAROLINE (NGR)

1. KNEER JOHANNA (GER)
2. BERULTSEVA SOFYA (KAZ)
3. WALTERS ROCHELLE (ENG)
3. KYDONAKI KYRIAKI (GRE)
5. CREEMERS INGRID (NED)
5. QUINTAL CATZIN GUADALUPE (MEX)
7. OKILA MENNA SHAABAN (EGY)
7. BULAY DARIIA (UKR)

*Seeded

Referees:			

Female Kumite 68+ Kg - Round Robin (each against each)

Karate World Championships - Individual World Championships - Cairo 2025, 3894+XV8, Al Estad, Qesm Than Madinet Nasr, Cairo Governorate 4436020, EGY

Tatami

Pool

2/8

1	(*13) OKILA M. (EGY)	
	#339 / 28.11	7 (*13) OKILA M. (EGY)
2	(*11) GOLOMBOS N. (CRO)	
		5
3	(*18) SUGITA S. (JPN)	
	#340 / 28.11	1 (*3) KNEER J. (GER)
4	(*3) KNEER J. (GER)	
		7
		PTS
5	(*11) GOLOMBOS N. (CRO)	
	#343 / 28.11	8 (*11) GOLOMBOS N. (CRO)
6	(*18) SUGITA S. (JPN)	
		2
7	(*13) OKILA M. (EGY)	
	#344 / 28.11	2
8	(*3) KNEER J. (GER)	
		2
		PTS
9	(*13) OKILA M. (EGY)	
	#347 / 28.11	6 (*13) OKILA M. (EGY)
10	(*18) SUGITA S. (JPN)	
		2
11	(*11) GOLOMBOS N. (CRO)	
	#348 / 28.11	1
12	(*3) KNEER J. (GER)	
		1

1. OKILA MENNA SHAABAN (EGY)
2. KNEER JOHANNA (GER)
3. GOLOMBOS NIKOLINA (CRO)
4. SUGITA SUMIRE (JPN)

1. KNEER JOHANNA (GER)
2. BERULTSEVA SOFYA (KAZ)
3. WALTERS ROCHELLE (ENG)
3. KYDONAKI KYRIAKI (GRE)
5. CREEMERS INGRID (NED)
5. QUINTAL CATZIN GUADALUPE (MEX)
7. OKILA MENNA SHAABAN (EGY)
7. BULAY DARIIA (UKR)

*Seeded

Referees:			

Female Kumite 68+ Kg - Round Robin (each against each)

Karate World Championships - Individual World Championships - Cairo 2025, 3894+XV8, Al Estad, Qesm Than Madinet Nasr, Cairo Governorate 4436020, EGY

Tatami

Pool

3/8

1	(*25) OLIVEIRA A. (POR)	#406 / 28.11	0
2	(*22) CREEMERS I. (NED)		0
3	(*6) BOYCE K. (AUS)	#407 / 28.11	0
4	(*12) RODRIGUEZ OGANDO P. (DOM)		6
5	(*22) CREEMERS I. (NED)	#410 / 28.11	5
6	(*6) BOYCE K. (AUS)		1
7	(*25) OLIVEIRA A. (POR)	#411 / 28.11	1
8	(*12) RODRIGUEZ OGANDO P. (DOM)		0
9	(*25) OLIVEIRA A. (POR)	#414 / 28.11	1
10	(*6) BOYCE K. (AUS)		0
11	(*22) CREEMERS I. (NED)	#415 / 28.11	6
12	(*12) RODRIGUEZ OGANDO P. (DOM)		2

1. CREEMERS INGRID (NED)
2. OLIVEIRA ANA RITA (POR)
3. RODRIGUEZ OGANDO PAMELA (DOM)
4. BOYCE KRYSTAL (AUS)

1. KNEER JOHANNA (GER)
2. BERULTSEVA SOFYA (KAZ)
3. WALTERS ROCHELLE (ENG)
3. KYDONAKI KYRIAKI (GRE)
5. CREEMERS INGRID (NED)
5. QUINTAL CATZIN GUADALUPE (MEX)
7. OKILA MENNA SHAABAN (EGY)
7. BULAY DARIIA (UKR)

*Seeded

Referees:			



















Female Kumite 68+ Kg - Round Robin (each against each)

Karate World Championships - Individual World Championships - Cairo 2025, 3894+XV8, Al Estad, Qesm Than Madinet Nasr, Cairo Governorate 4436020, EGY

Tatami

Pool

4/8

1	 (*26) COMAN M. (ROU)	#408 / 28.11	0	 (*28) BAO BEDNARSKI S. (SWE)
2	 (*28) BAO BEDNARSKI S. (SWE)		8	
3	 (*29) BEN TAIEB I. (TUN)	#409 / 28.11	3	 (*2) BERULTSEVA S. (KAZ)
4	 (*2) BERULTSEVA S. (KAZ)		3	
5	 (*28) BAO BEDNARSKI S. (SWE)	#412 / 28.11	5	 (*28) BAO BEDNARSKI S. (SWE)
6	 (*29) BEN TAIEB I. (TUN)		5	
7	 (*26) COMAN M. (ROU)	#413 / 28.11	3	 (*2) BERULTSEVA S. (KAZ)
8	 (*2) BERULTSEVA S. (KAZ)		3	
9	 (*26) COMAN M. (ROU)	#416 / 28.11	0	 (*29) BEN TAIEB I. (TUN)
10	 (*29) BEN TAIEB I. (TUN)		2	
11	 (*28) BAO BEDNARSKI S. (SWE)	#417 / 28.11	1	 (*2) BERULTSEVA S. (KAZ)
12	 (*2) BERULTSEVA S. (KAZ)		3	

1. BERULTSEVA SOFYA (KAZ)
2. BAO BEDNARSKI SOPHIE (SWE)
3. BEN TAIEB ISRA (TUN)
4. COMAN MARIA CRISTINA (ROU)

1. KNEER JOHANNA (GER)
2. BERULTSEVA SOFYA (KAZ)
3. WALTERS ROCHELLE (ENG)
3. KYDONAKI KYRIAKI (GRE)
5. CREEMERS INGRID (NED)
5. QUINTAL CATZIN GUADALUPE (MEX)
7. OKILA MENNA SHAABAN (EGY)
7. BULAY DARIIA (UKR)

*Seeded

Referees:			



















Female Kumite 68+ Kg - Round Robin (each against each)

Karate World Championships - Individual World Championships - Cairo 2025, 3894+XV8, Al Estad, Qesm Than Madinet Nasr, Cairo Governorate 4436020, EGY

Tatami

Pool

5/8

1	 (*17) FERRACUTI C. (ITA)	#478 / 28.11	4	 (*17) FERRACUTI C. (ITA)
2	 (*5) OUDIRA C. (ALG)		2	
		PTS		
3	 (*31) BULAY D. (UKR)	#479 / 28.11	5	 (*31) BULAY D. (UKR)
4	 (*9) PEREIRA B. (BRA)		5	
5	 (*5) OUDIRA C. (ALG)	#482 / 28.11	1	 (*31) BULAY D. (UKR)
6	 (*31) BULAY D. (UKR)		7	
		PTS		
7	 (*17) FERRACUTI C. (ITA)	#483 / 28.11	3	 (*17) FERRACUTI C. (ITA)
8	 (*9) PEREIRA B. (BRA)		0	
9	 (*17) FERRACUTI C. (ITA)	#486 / 28.11	6	 (*31) BULAY D. (UKR)
10	 (*31) BULAY D. (UKR)		7	
		PTS		
11	 (*5) OUDIRA C. (ALG)	#487 / 28.11	3	 (*5) OUDIRA C. (ALG)
12	 (*9) PEREIRA B. (BRA)		1	

1. BULAY DARIIA (UKR)
2. FERRACUTI CLIO (ITA)
3. OUDIRA CHAIMA (ALG)
4. PEREIRA BRENDA (BRA)

1. KNEER JOHANNA (GER)
2. BERULTSEVA SOFYA (KAZ)
3. WALTERS ROCHELLE (ENG)
3. KYDONAKI KYRIAKI (GRE)
5. CREEMERS INGRID (NED)
5. QUINTAL CATZIN GUADALUPE (MEX)
7. OKILA MENNA SHAABAN (EGY)
7. BULAY DARIIA (UKR)

*Seeded

















Referees:			

Female Kumite 68+ Kg - Round Robin (each against each)

Karate World Championships - Individual World Championships - Cairo 2025, 3894+XV8, Al Estad, Qesm Than Madinet Nasr, Cairo Governorate 4436020, EGY

Tatami

Pool
6/8

1	 (*7) ZILLER L. (AUT)	
	#480 / 28.11	10  (*7) ZILLER L. (AUT)
2	 (*32) KHAKIMJONOVA M. (UZB)	
	2	
3	 (*8) MULOLO O. (BEL)	
	#481 / 28.11	3  (*4) KYDONAKI K. (GRE)
4	 (*4) KYDONAKI K. (GRE)	
	5	
5	 (*32) KHAKIMJONOVA M. (UZB)	
	#484 / 28.11	1  (*8) MULOLO O. (BEL)
6	 (*8) MULOLO O. (BEL)	
	5	
7	 (*7) ZILLER L. (AUT)	
	#485 / 28.11	0  (*4) KYDONAKI K. (GRE)
8	 (*4) KYDONAKI K. (GRE)	
	5	
9	 (*7) ZILLER L. (AUT)	
	#488 / 28.11	0
10	 (*8) MULOLO O. (BEL)	
	0	
11	 (*32) KHAKIMJONOVA M. (UZB)	
	#489 / 28.11	0  (*4) KYDONAKI K. (GRE)
12	 (*4) KYDONAKI K. (GRE)	
	6	

1. KYDONAKI KYRIAKI (GRE)
2. ZILLER LORA (AUT)
3. MULOLO OPHELIE (BEL)
4. KHAKIMJONOVA MOKHLAROYIM (UZB)

1. KNEER JOHANNA (GER)
2. BERULTSEVA SOFYA (KAZ)
3. WALTERS ROCHELLE (ENG)
3. KYDONAKI KYRIAKI (GRE)
5. CREEMERS INGRID (NED)
5. QUINTAL CATZIN GUADALUPE (MEX)
7. OKILA MENNA SHAABAN (EGY)
7. BULAY DARIIA (UKR)

*Seeded

Referees:			

Female Kumite 68+ Kg - Round Robin (each against each)

Karate World Championships - Individual World Championships - Cairo 2025, 3894+XV8, Al Estad, Qesm Than Madinet Nasr, Cairo Governorate 4436020, EGY

Tatami

Pool

7/8

1	(*24) DANISZEWSKA J. (POL)	0	(*10) GONZALEZ LAVIN J. (CHI)
	#544 / 28.11		
2	(*10) GONZALEZ LAVIN J. (CHI)	1	
	PTS		
3	(*15) GARCIA N. (FRA)	4	(*15) GARCIA N. (FRA)
	#545 / 28.11		
4	(*21) GURUNG A. (NEP)	4	
5	(*10) GONZALEZ LAVIN J. (CHI)	0	(*15) GARCIA N. (FRA)
	#548 / 28.11		
6	(*15) GARCIA N. (FRA)	4	
	PTS		
7	(*24) DANISZEWSKA J. (POL)	2	(*24) DANISZEWSKA J. (POL)
	#549 / 28.11		
8	(*21) GURUNG A. (NEP)	0	
9	(*24) DANISZEWSKA J. (POL)	3	(*15) GARCIA N. (FRA)
	#552 / 28.11		
10	(*15) GARCIA N. (FRA)	3	
	PTS		
11	(*10) GONZALEZ LAVIN J. (CHI)	1	(*21) GURUNG A. (NEP)
	#553 / 28.11		
12	(*21) GURUNG A. (NEP)	5	

1. GARCIA NANCY (FRA)
2. GURUNG ARIKA (NEP)
3. GONZALEZ LAVIN JAVIERA (CHI)
4. DANISZEWSKA JULIA (POL)

1. KNEER JOHANNA (GER)
2. BERULTSEVA SOFYA (KAZ)
3. WALTERS ROCHELLE (ENG)
3. KYDONAKI KYRIAKI (GRE)
5. CREEMERS INGRID (NED)
5. QUINTAL CATZIN GUADALUPE (MEX)
7. OKILA MENNA SHAABAN (EGY)
7. BULAY DARIIA (UKR)

*Seeded

Referees:			

Female Kumite 68+ Kg - Round Robin (each against each)

Karate World Championships - Individual World Championships - Cairo 2025, 3894+XV8, Al Estad, Qesm Than Madinet Nasr, Cairo Governorate 4436020, EGY

Tatami

Pool
8/8

1	(*16) FLEISCHER D. (HUN)	0	(*19) NASER Y. (JOR)
	#546 / 28.11		
2	(*19) NASER Y. (JOR)	1	
3	(*27) JUNNER N. (SCO)	1	(*1) TORRES GARCIA M. (ESP)
	#547 / 28.11		
4	(*1) TORRES GARCIA M. (ESP)	4	
5	(*19) NASER Y. (JOR)	4	(*27) JUNNER N. (SCO)
	#550 / 28.11		
6	(*27) JUNNER N. (SCO)	4	
	PTS		
7	(*16) FLEISCHER D. (HUN)	3	(*16) FLEISCHER D. (HUN)
	#551 / 28.11		
8	(*1) TORRES GARCIA M. (ESP)	3	
9	(*16) FLEISCHER D. (HUN)	2	(*27) JUNNER N. (SCO)
	#554 / 28.11		
10	(*27) JUNNER N. (SCO)	3	
11	(*19) NASER Y. (JOR)	0	(*1) TORRES GARCIA M. (ESP)
	#555 / 28.11		
12	(*1) TORRES GARCIA M. (ESP)	7	

1. TORRES GARCIA MARIA (ESP)
2. JUNNER NIAMH (SCO)
3. NASER YARA (JOR)
4. FLEISCHER DORA (HUN)

1. KNEER JOHANNA (GER)
2. BERULTSEVA SOFYA (KAZ)
3. WALTERS ROCHELLE (ENG)
3. KYDONAKI KYRIAKI (GRE)
5. CREEMERS INGRID (NED)
5. QUINTAL CATZIN GUADALUPE (MEX)
7. OKILA MENNA SHAABAN (EGY)
7. BULAY DARIIA (UKR)

*Seeded

Referees:			

Pool winner-Female Kumite 68+ Kg

Karate World Championships - Individual World Championships - Cairo 2025, 3894+XV8, Al Estad, Qesm Than Madinet Nasr, Cairo Governorate 4436020, EGY

Tatami

Pool

1/1

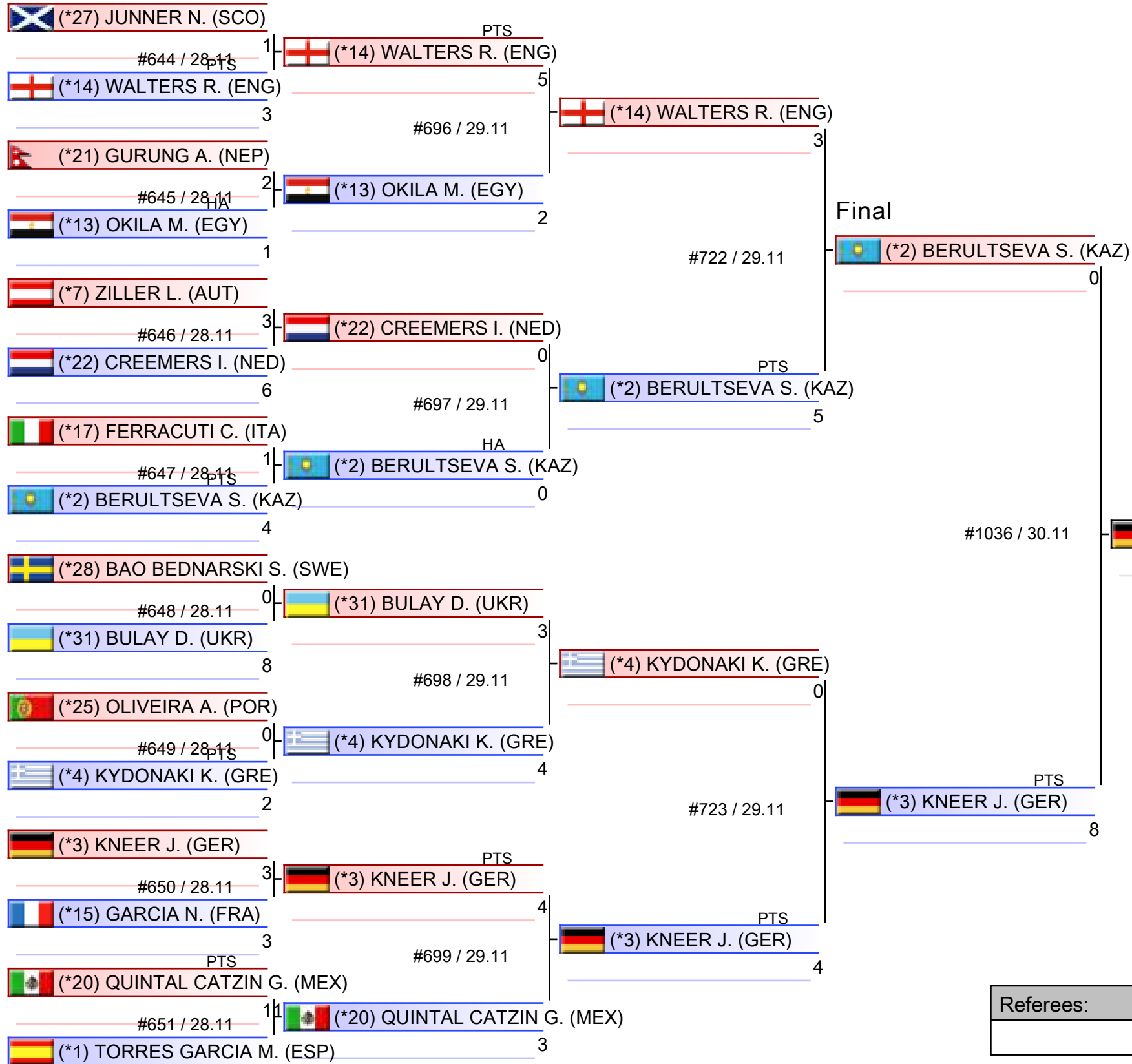

1. KNEER JOHANNA (GER)
2. BERULTSEVA SOFYA (KAZ)
3. WALTERS ROCHELLE (ENG)
3. KYDONAKI KYRIAKI (GRE)
5. CREEMERS INGRID (NED)
5. QUINTAL CATZIN GUADALUPE (MEX)
7. OKILA MENNA SHAABAN (EGY)
7. BULAY DARIIA (UKR)

*Seeded

Referees:			

Female Kumite 68+ Kg

Karate World Championships - Individual World Championships - Cairo 2025

Tatami

Pool

1,2,3,4,5,6,7,8

(c)sportdata GmbH & Co KG 2000-2025 (2025-12-02 21:54) v 11.0.0 build 2 (2025-11-22 17:48 CET) License: SDIL TVG ODF (expire 2026-01-23)

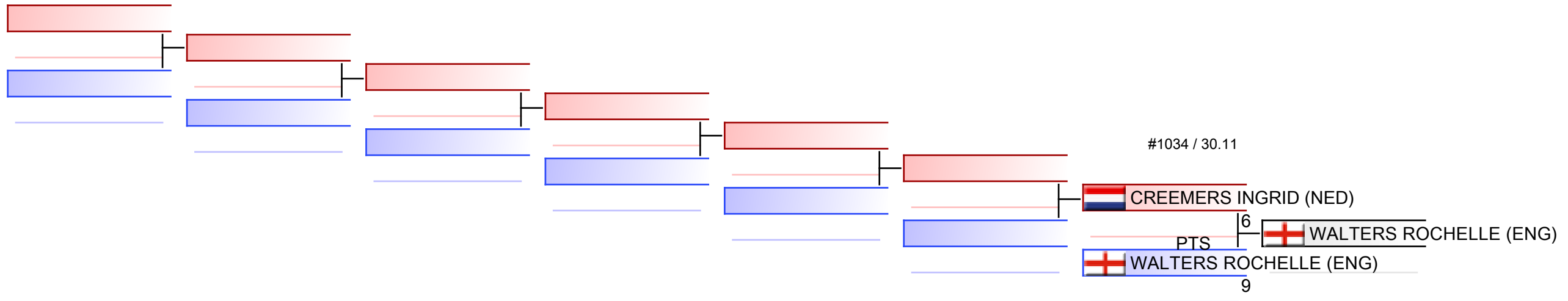

REPECHAGE: (1,2,3,4,5,6,7,8)

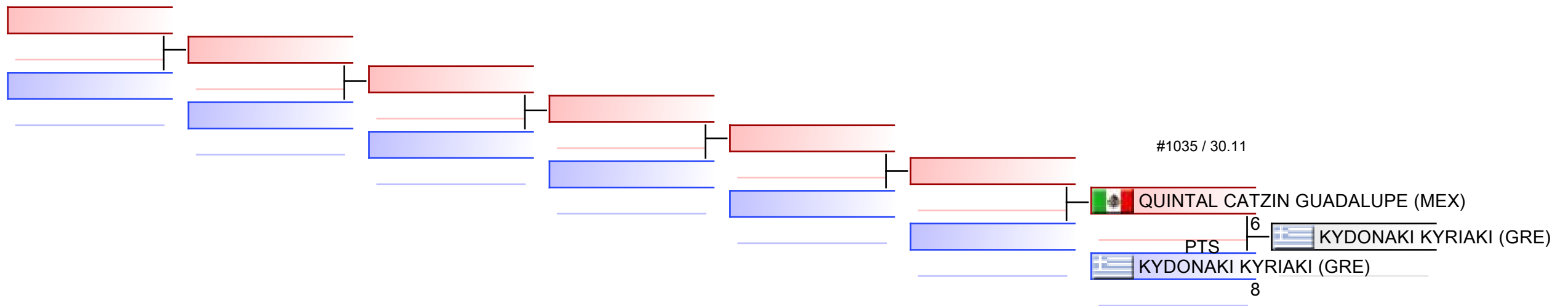

Referees:							
-----------	--	--	--	--	--	--	--



Karate World Championships - Individual World
Championships - Cairo 2025 - 2025-11-27



Official Results

Female Kumite 68+ Kg			
1	KNEER JOHANNA		GER - GERMANY
2	BERULTSEVA SOFYA		KAZ - KAZAKHSTAN
3	WALTERS ROCHELLE		ENG - ENGLAND
3	KYDONAKI KYRIAKI		GRE - GREECE
5	CREEMERS INGRID		NED - NETHERLANDS
5	QUINTAL CATZIN GUADALUPE		MEX - MEXICO
7	OKILA MENNA SHAABAN		EGY - EGYPT
7	BULAY DARIIA		UKR - UKRAINE

MALE KATA



Karate World Championships - Individual World Cha ..



ENTRIES BY WEIGHT CATEGORY

Male Kata

As of 2 DEC 2025

Code	ID	Gender	Name	Seeding
ALG	ALG03041	M	ZIAD YUCEF	5
ARG	ARG2093	M	IMPAGNATIELLO LUCA MATEO	6
AUS	AUS02705	M	FISHER DYLAN	7
AZE	AZE275	M	HEYDAROV ROMAN	8
BDI	BDI002289	M	MUKESHIMANA BRILLANT	9
CHN	CHN02572	M	YANG KANGWEI	22
COL	COL2007	M	RAMIREZ ALEJANDRO	11
DOM	DOM2119	M	DE CASTRO HERIBERTO	12
EGY	EGY2534	M	ELGHOBASHY MOSTAFA	13
ESP	ESP173	M	QUINTERO CAPDEVILA DAMIAN HUGO	28
FRA	FRA04085	M	KLEMZ THOMAS	14
GER	GER2092	M	TELLOCKE MORRIS	15
HKG	HKG162	M	HUNG HO WAI HOWARD	16
ITA	ITA2507	M	GHINAMI ALESSIO	3
JPN	JPN2470	M	NISHIYAMA KAKERU	1
KOR	KOR02163	M	HWANG TAEYEON	24
KUW	KUW186	M	ALMOSAWI SAYED SALMAN	17
MAR	MAR03097	M	LAMOUM TIJANI	19
MNE	MNE244	M	MIJAC VLADIMIR	18
NGR	NGR02147	M	OLORUNMBE OLUWASEUN	21
NZL	NZL195	M	ROWSBY NICHOLAS	20
POR	POR02545	M	NETO ARTUR	23
ROU	ROU2480	M	COMANESCU PETRU	25
SLO	SLO2458	M	SLUGA JURE	27
SUI	SUI2121	M	UJIHARA YUKI	30
SVK	SVK2199	M	HRCKA ROMAN	26
SWE	SWE02584	M	VU ANTHONY	29
TPE	TPE174	M	CHEN CHAO-CHING	10
TUR	TUR2430	M	OZDEMIR ENES	4
USA	USA283	M	TORRES GUTIERREZ ARIEL	2
VEN	VEN192	M	CASANOVA GUERRERO CLEIVER	31

Male Kata - Round Robin (each against each)

Karate World Championships - Individual World Championships - Cairo 2025, 3894+XV8, Al Estad, Qesm Than Madinet Nasr, Cairo Governorate 4436020, EGY

Tatami

Pool

1/8

1	 (*17) ALMOSAWI S. (KUW)	020 Gojushiho Dai #277 / 28.11	39.70	 (*17) ALMOSAWI S. (KUW)
2	 (*12) DE CASTRO H. (DOM)	064 Ohan Dai	38.30	
3	 (*26) HRCKA R. (SVK)	002 Anan Dai #278 / 28.11	39.90	 (*26) HRCKA R. (SVK)
4	 (*7) FISHER D. (AUS)	064 Ohan Dai	37.80	
5	 (*12) DE CASTRO H. (DOM)	009 Chibana No Kushanku #281 / 28.11	38.30	 (*26) HRCKA R. (SVK)
6	 (*26) HRCKA R. (SVK)	061 Nipaipo	40.30	
7	 (*17) ALMOSAWI S. (KUW)	021 Gojushiho Sho #282 / 28.11	39.50	 (*17) ALMOSAWI S. (KUW)
8	 (*7) FISHER D. (AUS)	002 Anan Dai	38.00	
9	 (*17) ALMOSAWI S. (KUW)	099 Unsu #285 / 28.11	40.20	 (*26) HRCKA R. (SVK)
10	 (*26) HRCKA R. (SVK)	068 Papuren	40.50	
11	 (*12) DE CASTRO H. (DOM)	068 Papuren #286 / 28.11	38.00	 (*12) DE CASTRO H. (DOM)
12	 (*7) FISHER D. (AUS)	063 Ohan	37.90	

1. HRCKA ROMAN (SVK)
2. ALMOSAWI SAYED SALMAN (KUW)
3. DE CASTRO HERIBERTO (DOM)
4. FISHER DYLAN (AUS)

1. NISHIYAMA KAKERU (JPN)
2. GHINAMI ALESSIO (ITA)
3. OZDEMIR ENES (TUR)
3. TORRES GUTIERREZ ARIEL (USA)
5. HRCKA ROMAN (SVK)
5. ELGHOBASHY MOSTAFA (EGY)
7. QUINTERO CAPDEVILA DAMIAN HUGO (ESP)
7. COMANESCU PETRU (ROU)

*Seeded

Referees:			

Male Kata - Round Robin (each against each)

Karate World Championships - Individual World Championships - Cairo 2025, 3894+XV8, Al Estad, Qesm Than Madinet Nasr, Cairo Governorate 4436020, EGY

Tatami

Pool
2/8

1	 (*16) HUNG H. (HKG)	063 Ohan #279 / 28.11	39.90	 (*13) ELGHOBASHY M. (EGY)
2	 (*13) ELGHOBASHY M. (EGY)	041 Kanku Sho	40.60	
3	 (*14) KLEMZ T. (FRA)	002 Anan Dai #280 / 28.11	39.40	 (*3) GHINAMI A. (ITA)
4	 (*3) GHINAMI A. (ITA)	041 Kanku Sho	41.20	
5	 (*13) ELGHOBASHY M. (EGY)	020 Gojushiho Dai #283 / 28.11	40.80	 (*13) ELGHOBASHY M. (EGY)
6	 (*14) KLEMZ T. (FRA)	064 Ohan Dai	39.30	
7	 (*16) HUNG H. (HKG)	009 Chibana No Kushanku #284 / 28.11	39.60	 (*3) GHINAMI A. (ITA)
8	 (*3) GHINAMI A. (ITA)	099 Unsu	41.50	
9	 (*16) HUNG H. (HKG)	064 Ohan Dai #287 / 28.11	39.80	 (*14) KLEMZ T. (FRA)
10	 (*14) KLEMZ T. (FRA)	092 Suparinpei	39.90	
11	 (*13) ELGHOBASHY M. (EGY)	021 Gojushiho Sho #288 / 28.11	40.70	 (*3) GHINAMI A. (ITA)
12	 (*3) GHINAMI A. (ITA)	015 Gankaku	42.20	

1. GHINAMI ALESSIO (ITA)
2. ELGHOBASHY MOSTAFA (EGY)
3. KLEMZ THOMAS (FRA)
4. HUNG HO WAI HOWARD (HKG)

1. NISHIYAMA KAKERU (JPN)
2. GHINAMI ALESSIO (ITA)
3. OZDEMIR ENES (TUR)
3. TORRES GUTIERREZ ARIEL (USA)
5. HRCKA ROMAN (SVK)
5. ELGHOBASHY MOSTAFA (EGY)
7. QUINTERO CAPDEVILA DAMIAN HUGO (ESP)
7. COMANESCU PETRU (ROU)

*Seeded

Referees:			

Male Kata - Round Robin (each against each)

Karate World Championships - Individual World Championships - Cairo 2025, 3894+XV8, Al Estad, Qesm Than Madinet Nasr, Cairo Governorate 4436020, EGY

Tatami

Pool

3/8

1	(*30) UJIHARA Y. (SUI)	047 Kururunfa #349 / 28.11	40	(*30) UJIHARA Y. (SUI)
2	(*31) CASANOVA GUERRERO C. (VEN)	099 Unsu	38.30	
3	(*20) ROWSBY N. (NZL)	008 Chatanyara Kushanku3 #350 / 28.11	37	(*10) CHEN C. (TPE)
4	(*10) CHEN C. (TPE)	063 Ohan	39.20	
5	(*31) CASANOVA GUERRERO C. (VEN)	091 Sochin #353 / 28.11	38	(*31) CASANOVA GUERRERO C. (VEN)
6	(*20) ROWSBY N. (NZL)	068 Papuren	37.50	
7	(*30) UJIHARA Y. (SUI)	068 Papuren #354 / 28.11	39	(*10) CHEN C. (TPE)
8	(*10) CHEN C. (TPE)	064 Ohan Dai	40.00	
9	(*30) UJIHARA Y. (SUI)	080 Sanseru #357 / 28.11	39	(*30) UJIHARA Y. (SUI)
10	(*20) ROWSBY N. (NZL)	043 Kishimoto No Kushan #356 / 28.11	36.20	
11	(*31) CASANOVA GUERRERO C. (VEN)	020 Gojushiho Dai #358 / 28.11	37	(*10) CHEN C. (TPE)
12	(*10) CHEN C. (TPE)	068 Papuren	40.20	

1. CHEN CHAO-CHING (TPE)
2. UJIHARA YUKI (SUI)
3. CASANOVA GUERRERO CLEIVER (VEN)
4. ROWSBY NICHOLAS (NZL)

1. NISHIYAMA KAKERU (JPN)
2. GHINAMI ALESSIO (ITA)
3. OZDEMIR ENES (TUR)
3. TORRES GUTIERREZ ARIEL (USA)
5. HRCKA ROMAN (SVK)
5. ELGHOBASHY MOSTAFA (EGY)
7. QUINTERO CAPDEVILA DAMIAN HUGO (ESP)
7. COMANESCU PETRU (ROU)

*Seeded

Referees:			







Male Kata - Round Robin (each against each)

Karate World Championships - Individual World Championships - Cairo 2025, 3894+XV8, Al Estad, Qesm Than Madinet Nasr, Cairo Governorate 4436020, EGY

Tatami

Pool

4/8

1	 (*21) OLORUNMBE O. (NGR)	092 Suparinpei #351 / 28.11	36.20	 (*22) YANG K. (CHN)
2	 (*22) YANG K. (CHN)	063 Ohan	38.70	
3	 (*25) COMANESCU P. (ROU)	091 Sochin #352 / 28.11	38.90	 (*2) TORRES GUTIERREZ A. (USA)
4	 (*2) TORRES GUTIERREZ A. (USA)	047 Kururunfa	40.70	
5	 (*22) YANG K. (CHN)	009 Chibana No Kushanku #355 / 28.11	39.40	 (*25) COMANESCU P. (ROU)
6	 (*25) COMANESCU P. (ROU)	099 Unsu	39.50	
7	 (*21) OLORUNMBE O. (NGR)	001 Anan #356 / 28.11	35.80	 (*2) TORRES GUTIERREZ A. (USA)
8	 (*2) TORRES GUTIERREZ A. (USA)	090 Shisochin	40.40	
9	 (*21) OLORUNMBE O. (NGR)	061 Nipaipo #359 / 28.11	34.90	 (*25) COMANESCU P. (ROU)
10	 (*25) COMANESCU P. (ROU)	021 Gojushiho Sho	39.70	
11	 (*22) YANG K. (CHN)	068 Papuren #360 / 28.11	39.20	 (*2) TORRES GUTIERREZ A. (USA)
12	 (*2) TORRES GUTIERREZ A. (USA)	079 Sanseiru	41.40	

1. TORRES GUTIERREZ ARIEL (USA)
2. COMANESCU PETRU (ROU)
3. YANG KANGWEI (CHN)
4. OLORUNMBE OLUWASEUN (NGR)

1. NISHIYAMA KAKERU (JPN)
2. GHINAMI ALESSIO (ITA)
3. OZDEMIR ENES (TUR)
3. TORRES GUTIERREZ ARIEL (USA)
5. HRCKA ROMAN (SVK)
5. ELGHOBASHY MOSTAFA (EGY)
7. QUINTERO CAPDEVILA DAMIAN HUGO (ESP)
7. COMANESCU PETRU (ROU)

*Seeded

Referees:			



















Male Kata - Round Robin (each against each)

Karate World Championships - Individual World Championships - Cairo 2025, 3894+XV8, Al Estad, Qesm Than Madinet Nasr, Cairo Governorate 4436020, EGY

Tatami

Pool

5/8

1	 (*9) MUKESHIMANA B. (BDI)	092 Suparinpei #418 / 28.11	35.60	 (*6) IMPAGNATIELLO L. (ARG)
2	 (*6) IMPAGNATIELLO L. (ARG)	021 Gojushiho Sho	38.20	
3	 (*23) NETO A. (POR)	008 Chatanyara Kushanku #419 / 28.11	37.90	 (*23) NETO A. (POR)
4	 (*8) HEYDAROV R. (AZE)	020 Gojushiho Dai	37.60	
5	 (*6) IMPAGNATIELLO L. (ARG)	092 Suparinpei #422 / 28.11	37.40	 (*23) NETO A. (POR)
6	 (*23) NETO A. (POR)	002 Anan Dai	38.60	
7	 (*9) MUKESHIMANA B. (BDI)	008 Chatanyara Kushanku #423 / 28.11	35.90	 (*8) HEYDAROV R. (AZE)
8	 (*8) HEYDAROV R. (AZE)	091 Sochin	37.80	
9	 (*9) MUKESHIMANA B. (BDI)	021 Gojushiho Sho #426 / 28.11	36.00	 (*23) NETO A. (POR)
10	 (*23) NETO A. (POR)	001 Anan	38.50	
11	 (*6) IMPAGNATIELLO L. (ARG)	099 Unsu #427 / 28.11	38.10	 (*8) HEYDAROV R. (AZE)
12	 (*8) HEYDAROV R. (AZE)	021 Gojushiho Sho	38.40	

1. NETO ARTUR (POR)
2. HEYDAROV ROMAN (AZE)
3. IMPAGNATIELLO LUCA MATEO (ARG)
4. MUKESHIMANA BRILLANT (BDI)

1. NISHIYAMA KAKERU (JPN)
2. GHINAMI ALESSIO (ITA)
3. OZDEMIR ENES (TUR)
3. TORRES GUTIERREZ ARIEL (USA)
5. HRCKA ROMAN (SVK)
5. ELGHOBASHY MOSTAFA (EGY)
7. QUINTERO CAPDEVILA DAMIAN HUGO (ESP)
7. COMANESCU PETRU (ROU)

*Seeded

Referees:			

Male Kata - Round Robin (each against each)

Karate World Championships - Individual World Championships - Cairo 2025, 3894+XV8, Al Estad, Qesm Than Madinet Nasr, Cairo Governorate 4436020, EGY

Tatami

Pool

6/8

1	(*24) HWANG T. (KOR)	099 Unsu #420 / 28.11	38.20	(*24) HWANG T. (KOR)
2	(*19) LAMOUM T. (MAR)	021 Gojushiho Sho	38.00	
3	(*28) QUINTERO CAPDEVILA D. (ESP)	092 Suparinpei #421 / 28.11	39.80	(*4) OZDEMIR E. (TUR)
4	(*4) OZDEMIR E. (TUR)	021 Gojushiho Sho	41.00	
5	(*19) LAMOUM T. (MAR)	099 Unsu #424 / 28.11	37.90	(*28) QUINTERO CAPDEVILA D. (ESP)
6	(*28) QUINTERO CAPDEVILA D. (ESP)	066 Pachu	39.80	
7	(*24) HWANG T. (KOR)	041 Kanku Sho #425 / 28.11	37.20	(*4) OZDEMIR E. (TUR)
8	(*4) OZDEMIR E. (TUR)	091 Sochin	40.60	
9	(*24) HWANG T. (KOR)	021 Gojushiho Sho #428 / 28.11	37.40	(*28) QUINTERO CAPDEVILA D. (ESP)
10	(*28) QUINTERO CAPDEVILA D. (ESP)	067 Paiku	39.60	
11	(*19) LAMOUM T. (MAR)	020 Gojushiho Dai #429 / 28.11	38.00	(*4) OZDEMIR E. (TUR)
12	(*4) OZDEMIR E. (TUR)	020 Gojushiho Dai	40.00	

1. OZDEMIR ENES (TUR)
2. QUINTERO CAPDEVILA DAMIAN HUGO (ESP)
3. HWANG TAEYEON (KOR)
4. LAMOUM TIJANI (MAR)

1. NISHIYAMA KAKERU (JPN)
2. GHINAMI ALESSIO (ITA)
3. OZDEMIR ENES (TUR)
3. TORRES GUTIERREZ ARIEL (USA)
5. HRCKA ROMAN (SVK)
5. ELGHOBASHY MOSTAFA (EGY)
7. QUINTERO CAPDEVILA DAMIAN HUGO (ESP)
7. COMANESCU PETRU (ROU)

*Seeded

Referees:			



















Male Kata - Round Robin (each against each)

Karate World Championships - Individual World Championships - Cairo 2025, 3894+XV8, Al Estad, Qesm Than Madinet Nasr, Cairo Governorate 4436020, EGY

Tatami

Pool

7/8

1	 (*5) ZIAD Y. (ALG)	020 Gojushiho Dai #490 / 28.11	38.50	 (*29) VU A. (SWE)
2	 (*29) VU A. (SWE)	064 Ohan Dai	39.30	
3	 (*11) RAMIREZ A. (COL)	041 Kanku Sho #491 / 28.11	38.40	 (*15) TELLOCKE M. (GER)
4	 (*15) TELLOCKE M. (GER)	064 Ohan Dai	39.60	
5	 (*29) VU A. (SWE)	001 Anan #493 / 28.11	39.90	 (*29) VU A. (SWE)
6	 (*11) RAMIREZ A. (COL)	099 Unsu	37.80	
7	 (*5) ZIAD Y. (ALG)	021 Gojushiho Sho #494 / 28.11	39.00	 (*5) ZIAD Y. (ALG)
8	 (*15) TELLOCKE M. (GER)	001 Anan	37.70	
9	 (*5) ZIAD Y. (ALG)	099 Unsu #496 / 28.11	39.80	 (*5) ZIAD Y. (ALG)
10	 (*11) RAMIREZ A. (COL)	021 Gojushiho Sho	37.80	
11	 (*29) VU A. (SWE)	068 Papuren #497 / 28.11	39.70	 (*29) VU A. (SWE)
12	 (*15) TELLOCKE M. (GER)	092 Suparinpei	37.90	

1. VU ANTHONY (SWE)
2. ZIAD YUCEF (ALG)
3. TELLOCKE MORRIS (GER)
4. RAMIREZ ALEJANDRO (COL)

1. NISHIYAMA KAKERU (JPN)
2. GHINAMI ALESSIO (ITA)
3. OZDEMIR ENES (TUR)
3. TORRES GUTIERREZ ARIEL (USA)
5. HRCKA ROMAN (SVK)
5. ELGHOBASHY MOSTAFA (EGY)
7. QUINTERO CAPDEVILA DAMIAN HUGO (ESP)
7. COMANESCU PETRU (ROU)

*Seeded









Referees:			

Male Kata - Round Robin (each against each)

Karate World Championships - Individual World Championships - Cairo 2025, 3894+XV8, Al Estad, Qesm Than Madinet Nasr, Cairo Governorate 4436020, EGY

Tatami

Pool
8/8

1	 (*18) MIJAC V. (MNE)	021 Gojushihō Sho #492 / 28.11	38.20	 (*18) MIJAC V. (MNE)
2	 (*27) SLUGA J. (SLO)	078 Sansai	37.10	
3	 (*18) MIJAC V. (MNE)	091 Sochin #498 / 28.11	38.30	 (*1) NISHIYAMA K. (JPN)
4	 (*1) NISHIYAMA K. (JPN)	090 Shisochin	41.00	
5	 (*27) SLUGA J. (SLO)	021 Gojushihō Sho #495 / 28.11	38.20	 (*1) NISHIYAMA K. (JPN)
6	 (*1) NISHIYAMA K. (JPN)	047 Kururunfa	41.60	

1. NISHIYAMA KAKERU (JPN)
2. MIJAC VLADIMIR (MNE)
3. SLUGA JURE (SLO)

1. NISHIYAMA KAKERU (JPN)
2. GHINAMI ALESSIO (ITA)
3. OZDEMIR ENES (TUR)
3. TORRES GUTIERREZ ARIEL (USA)
5. HRCKA ROMAN (SVK)
5. ELGHOBASHY MOSTAFA (EGY)
7. QUINTERO CAPDEVILA DAMIAN HUGO (ESP)
7. COMANESCU PETRU (ROU)

*Seeded

Referees:			

Pool winner-Male Kata

Karate World Championships - Individual World Championships - Cairo 2025, 3894+XV8, Al Estad, Qesm Than Madinet Nasr, Cairo Governorate 4436020, EGY

Tatami

Pool
1/1

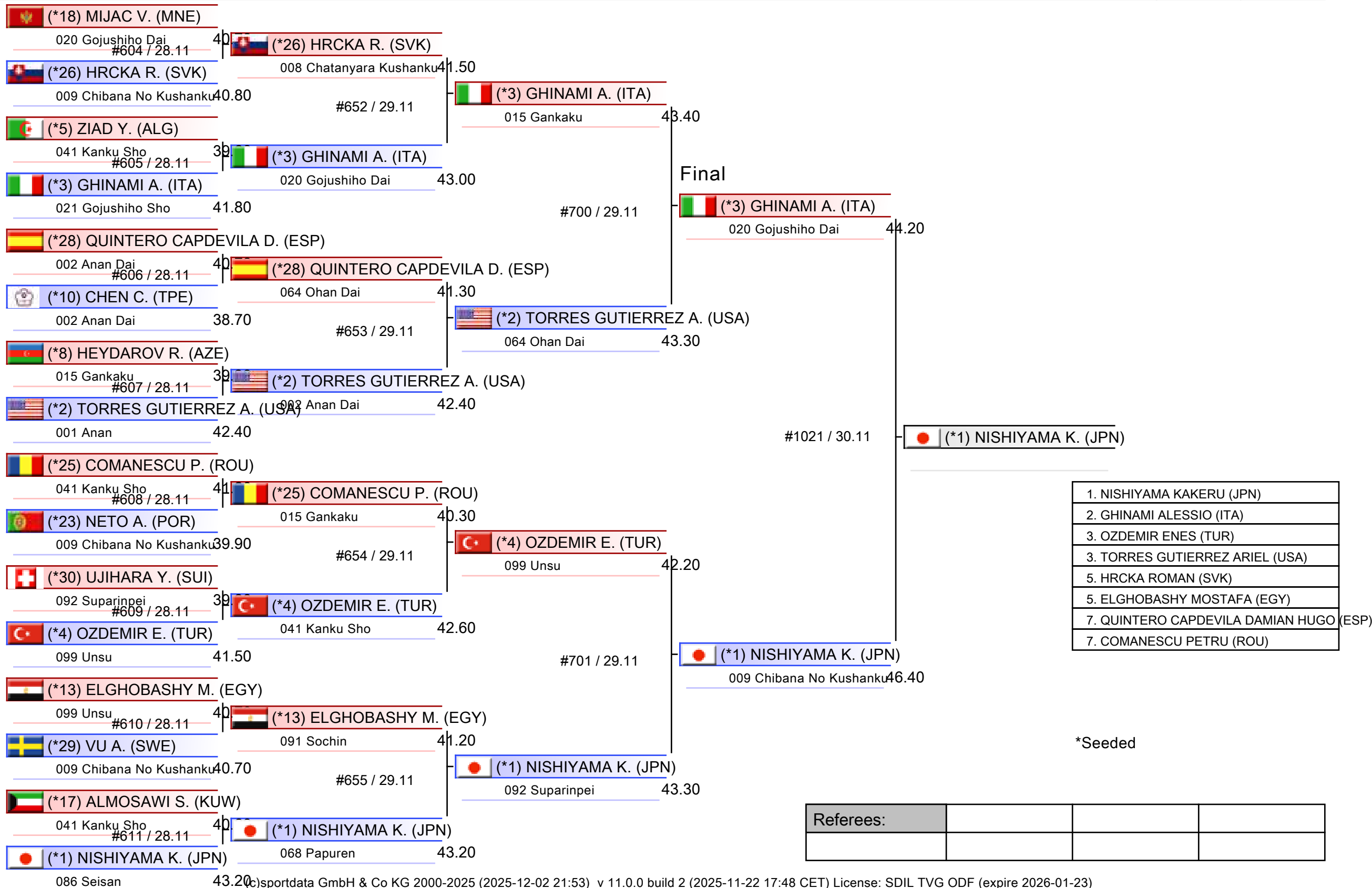

Male Kata

Karate World Championships - Individual World Championships - Cairo 2025

Tatami

Pool
1,2,3,4,5,6,7,8

(c)sportdata GmbH & Co KG 2000-2025 (2025-12-02 21:54) v 11.0.0 build 2 (2025-11-22 17:48 CET) License: SDIL TVG ODF (expire 2026-01-23)

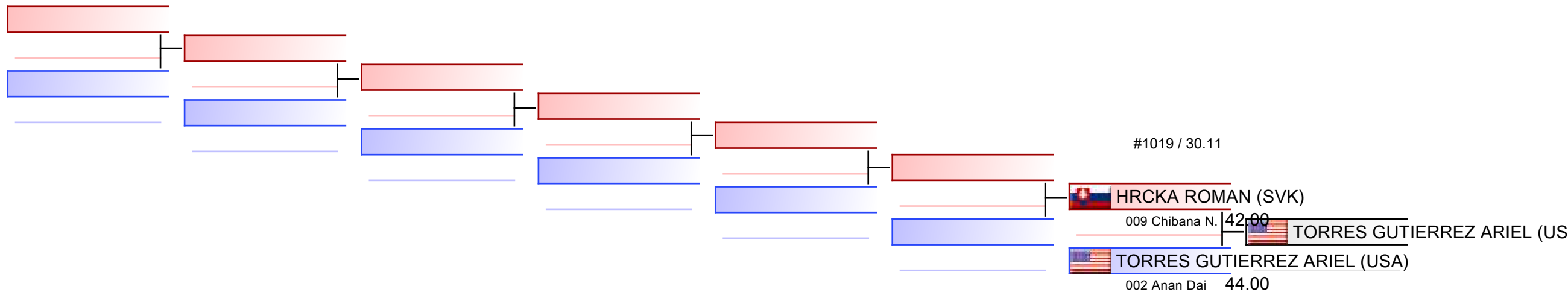

REPECHAGE: (1,2,3,4,5,6,7,8)

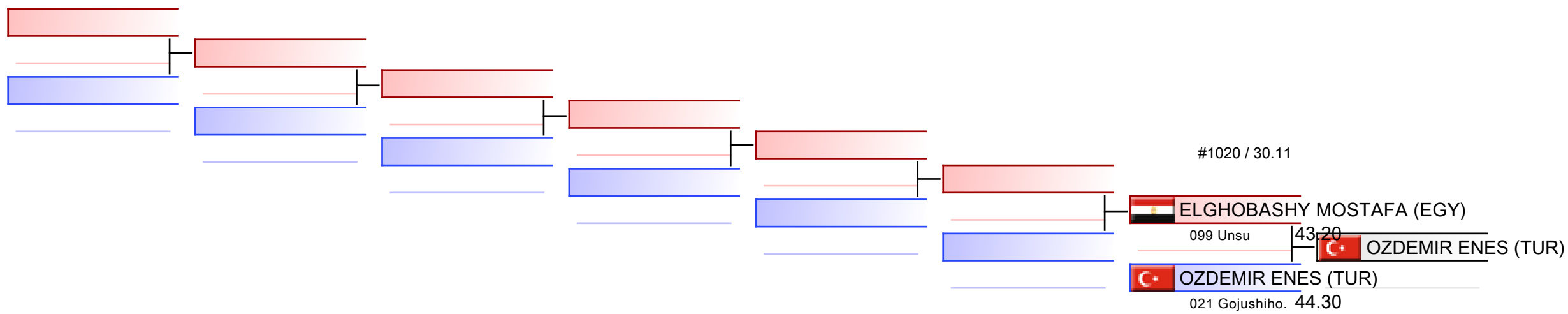

Referees:							
-----------	--	--	--	--	--	--	--



Karate World Championships - Individual World Championships - Cairo 2025 - 2025-11-27



Official Results

Male Kata			
1	NISHIYAMA KAKERU		JPN - JAPAN
2	GHINAMI ALESSIO		ITA - ITALY
3	OZDEMIR ENES		TUR - TURKIYE
3	TORRES GUTIERREZ ARIEL		USA - UNITED STATES
5	HRCKA ROMAN		SVK - SLOVAKIA
5	ELGHOBASHY MOSTAFA		EGY - EGYPT
7	QUINTERO CAPDEVILA DAMIAN HUGO		ESP - SPAIN
7	COMANESCU PETRU		ROU - ROMANIA

MALE KUMITE -60 KG



Karate World Championships - Individual World Cha ..



ENTRIES BY WEIGHT CATEGORY

Male Kumite -60 Kg

As of 2 DEC 2025

Code	ID	Gender	Name	Seeding
ALB	ALB2002	M	ARIFI ORGES	5
ARG	ARG02552	M	GALLARDO JUAN IGNACIO	6
AUS	AUS2375	M	SQUIRE DECLAN	7
BEL	BEL2201	M	ABDELMALKI ANASS	8
BEN	BEN02086	M	KPADONOU MARTIAL	9
BUR	BUR02123	M	KABORE MOHAMED	10
CHI	CHI2033	M	QUIJADA PELAYO MATIAS	11
COL	COL02565	M	FORERO JUAN	13
EGY	EGY2208	M	ALY ZYAD ELGHARIB	4
GEO	GEO02600	M	SORDIA TSOTNE	14
GRE	GRE521	M	XENOS CHRISTOS-STEFANOS	2
GUA	GUA2029	M	DE LA ROCA PEDROPABLO	15
IRI	IRI2143	M	MESKINI ALI	16
ITA	ITA266	M	CRESCENZO ANGELO	17
JOR	JOR2141	M	HAMMAD ABDALLAH	18
JPN	JPN03258	M	HASHIMOTO HIROMU	1
KAZ	KAZ2006	M	ALPYSBAY KAISAR	19
KGZ	KGZ002616	M	KALYKOV BEKZHAN	22
KOS	KOS2347	M	SELMANI ISLAM	20
KSA	KSA153	M	ALBASHER SAUD	26
KUW	KUW188	M	SHAABAN ABDULLAH	21
MKD	MKD533	M	VESELI FAHIK	24
MNE	MNE2277	M	VOJINOVIC BALSA	23
ROU	ROU2183	M	TORNACI ERHAN	25
THA	THA2221	M	MUEKTHONG SIWAKON	27
TPE	TPE02734	M	HSU LI-WEI	12
TUN	TUN02620	M	AYAT MOHAMED	28
TUR	TUR632	M	SAMDAN ERAY	3
UKR	UKR2283	M	FILIPOV NIKITA	29
UZB	UZB02713	M	TURAKHONOV MEKHRIDDIN	30
VEN	VEN003431	M	CHATAING JHOISBER	31
WKF-1	RUS2881	M	AKHMEDOV AKHMED	32

Male Kumite -60 Kg - Round Robin (each against each)

Karate World Championships - Individual World Championships - Cairo 2025, 3894+XV8, Al Estad, Qesm Than Madinet Nasr, Cairo Governorate 4436020, EGY

Tatami

Pool

1/8

1	 (*17) CRESCENZO A. (ITA)	#13 / 27.11	0	
2	 (*21) SHAABAN A. (KUW)		0	
		PTS		
3	 (*14) SORDIA T. (GEO)	#14 / 27.11	4	 (*14) SORDIA T. (GEO)
4	 (*15) DE LA ROCA P. (GUA)		1	
		PTS		
5	 (*21) SHAABAN A. (KUW)	#17 / 27.11	5	 (*21) SHAABAN A. (KUW)
6	 (*14) SORDIA T. (GEO)		1	
		PTS		
7	 (*17) CRESCENZO A. (ITA)	#18 / 27.11	2	 (*15) DE LA ROCA P. (GUA)
8	 (*15) DE LA ROCA P. (GUA)		4	
		PTS		
9	 (*17) CRESCENZO A. (ITA)	#21 / 27.11	0	 (*14) SORDIA T. (GEO)
10	 (*14) SORDIA T. (GEO)		4	
		PTS		
11	 (*21) SHAABAN A. (KUW)	#22 / 27.11	0	 (*15) DE LA ROCA P. (GUA)
12	 (*15) DE LA ROCA P. (GUA)		6	
		PTS		

1. SORDIA TSOTNE (GEO)
2. DE LA ROCA PEDROPABLO (GUA)
3. SHAABAN ABDULLAH (KUW)
4. CRESCENZO ANGELO (ITA)

1. SAMDAN ERAY (TUR)
2. SELMANI ISLAM (KOS)
3. HASHIMOTO HIROMU (JPN)
3. XENOS CHRISTOS-STEFANOS (GRE)
5. SORDIA TSOTNE (GEO)
5. TURAKHONOV MEKHRIDDIN (UZB)
7. AKHMEDOV AKHMED (WKF-1)
7. MESKINI ALI (IRI)

*Seeded









Referees:			

Male Kumite -60 Kg - Round Robin (each against each)

Karate World Championships - Individual World Championships - Cairo 2025, 3894+XV8, Al Estad, Qesm Than Madinet Nasr, Cairo Governorate 4436020, EGY

Tatami

Pool
2/8

1	 (*20) SELMANI I. (KOS)	
	#15 / 27.11	3
2	 (*31) CHATAING J. (VEN)	
		3
3	 (*22) KALYKOV B. (KGZ)	
	#16 / 27.11	0
4	 (*3) SAMDAN E. (TUR)	
		7
5	 (*31) CHATAING J. (VEN)	
	#19 / 27.11	1
6	 (*22) KALYKOV B. (KGZ)	
		3
	PTS	
7	 (*20) SELMANI I. (KOS)	
	#20 / 27.11	3
8	 (*3) SAMDAN E. (TUR)	
		1
9	 (*20) SELMANI I. (KOS)	
	#23 / 27.11	0
10	 (*22) KALYKOV B. (KGZ)	
		0
11	 (*31) CHATAING J. (VEN)	
	#24 / 27.11	0
12	 (*3) SAMDAN E. (TUR)	
		2

1. SAMDAN ERAY (TUR)
2. SELMANI ISLAM (KOS)
3. KALYKOV BEKZHAN (KGZ)
4. CHATAING JHOISBER (VEN)

1. SAMDAN ERAY (TUR)
2. SELMANI ISLAM (KOS)
3. HASHIMOTO HIROMU (JPN)
3. XENOS CHRISTOS-STEFANOS (GRE)
5. SORDIA TSOTNE (GEO)
5. TURAKHONOV MEKHRIDDIN (UZB)
7. AKHMEDOV AKHMED (WKF-1)
7. MESKINI ALI (IRI)

*Seeded

















Referees:			

Male Kumite -60 Kg - Round Robin (each against each)

Karate World Championships - Individual World Championships - Cairo 2025, 3894+XV8, Al Estad, Qesm Than Madinet Nasr, Cairo Governorate 4436020, EGY

Tatami

Pool
3/8

1	 (*8) ABDELMALKI A. (BEL)	#85 / 27.11	1	
2	 (*13) FORERO J. (COL)		1	
3	 (*30) TURAKHONOV M. (UZB)	#86 / 27.11	0	 (*32) AKHMEDOV A. (WKF-1)
4	 (*32) AKHMEDOV A. (WKF-1)		10	
5	 (*13) FORERO J. (COL)	#89 / 27.11	2	 (*30) TURAKHONOV M. (UZB)
6	 (*30) TURAKHONOV M. (UZB)		4	
7	 (*8) ABDELMALKI A. (BEL)	#90 / 27.11	4	 (*8) ABDELMALKI A. (BEL)
8	 (*32) AKHMEDOV A. (WKF-1)		0	
9	 (*8) ABDELMALKI A. (BEL)	#93 / 27.11	1	 (*30) TURAKHONOV M. (UZB)
10	 (*30) TURAKHONOV M. (UZB)		5	
11	 (*13) FORERO J. (COL)	#94 / 27.11	3	 (*32) AKHMEDOV A. (WKF-1)
12	 (*32) AKHMEDOV A. (WKF-1)		4	

1. AKHMEDOV AKHMED (WKF-1)
2. TURAKHONOV MEKHRIDDIN (UZB)
3. ABDELMALKI ANASS (BEL)
4. FORERO JUAN (COL)

1. SAMDAN ERAY (TUR)
2. SELMANI ISLAM (KOS)
3. HASHIMOTO HIROMU (JPN)
3. XENOS CHRISTOS-STEFANOS (GRE)
5. SORDIA TSOTNE (GEO)
5. TURAKHONOV MEKHRIDDIN (UZB)
7. AKHMEDOV AKHMED (WKF-1)
7. MESKINI ALI (IRI)

*Seeded

Referees:			

















Male Kumite -60 Kg - Round Robin (each against each)

Karate World Championships - Individual World Championships - Cairo 2025, 3894+XV8, Al Estad, Qesm Than Madinet Nasr, Cairo Governorate 4436020, EGY

Tatami

Pool

4/8

1	 (*29) FILIPOV N. (UKR)	3	 (*29) FILIPOV N. (UKR)
	#87 / 27.11		
2	 (*10) KABORE M. (BUR)	2	
3	 (*16) MESKINI A. (IRI)	0	 (*2) XENOS C. (GRE)
	#88 / 27.11		
4	 (*2) XENOS C. (GRE)	4	
5	 (*10) KABORE M. (BUR)	0	 (*16) MESKINI A. (IRI)
	#91 / 27.11		
6	 (*16) MESKINI A. (IRI)	9	
7	 (*29) FILIPOV N. (UKR)	2	 (*2) XENOS C. (GRE)
	#92 / 27.11		
8	 (*2) XENOS C. (GRE)	2	
9	 (*29) FILIPOV N. (UKR)	0	
	#95 / 27.11		
10	 (*16) MESKINI A. (IRI)	0	
11	 (*10) KABORE M. (BUR)	0	 (*2) XENOS C. (GRE)
	#96 / 27.11		
12	 (*2) XENOS C. (GRE)	7	

1. XENOS CHRISTOS-STEFANOS (GRE)
2. MESKINI ALI (IRI)
3. FILIPOV NIKITA (UKR)
4. KABORE MOHAMED (BUR)

1. SAMDAN ERAY (TUR)
2. SELMANI ISLAM (KOS)
3. HASHIMOTO HIROMU (JPN)
3. XENOS CHRISTOS-STEFANOS (GRE)
5. SORDIA TSOTNE (GEO)
5. TURAKHONOV MEKHRIDDIN (UZB)
7. AKHMEDOV AKHMED (WKF-1)
7. MESKINI ALI (IRI)

*Seeded

Referees:			

Male Kumite -60 Kg - Round Robin (each against each)

Karate World Championships - Individual World Championships - Cairo 2025, 3894+XV8, Al Estad, Qesm Than Madinet Nasr, Cairo Governorate 4436020, EGY

Tatami

Pool
5/8

1	(*18) HAMMAD A. (JOR)	#157 / 27.11	6	(*18) HAMMAD A. (JOR)
2	(*9) KPADONOU M. (BEN)		1	
3	(*23) VOJINOVIC B. (MNE)	#158 / 27.11	0	(*11) QUIJADA PELAYO M. (CHI)
4	(*11) QUIJADA PELAYO M. (CHI)		1	
5	(*9) KPADONOU M. (BEN)	#161 / 27.11	1	(*23) VOJINOVIC B. (MNE)
6	(*23) VOJINOVIC B. (MNE)		6	
7	(*18) HAMMAD A. (JOR)	#162 / 27.11	2	(*18) HAMMAD A. (JOR)
8	(*11) QUIJADA PELAYO M. (CHI)		0	
9	(*18) HAMMAD A. (JOR)	#165 / 27.11	6	(*18) HAMMAD A. (JOR)
10	(*23) VOJINOVIC B. (MNE)		6	
11	(*9) KPADONOU M. (BEN)	#166 / 27.11	5	(*9) KPADONOU M. (BEN)
12	(*11) QUIJADA PELAYO M. (CHI)		4	

1. HAMMAD ABDALLAH (JOR)
2. VOJINOVIC BALSA (MNE)
3. KPADONOU MARTIAL (BEN)
4. QUIJADA PELAYO MATIAS (CHI)

1. SAMDAN ERAY (TUR)
2. SELMANI ISLAM (KOS)
3. HASHIMOTO HIROMU (JPN)
3. XENOS CHRISTOS-STEFANOS (GRE)
5. SORDIA TSOTNE (GEO)
5. TURAKHONOV MEKHRIDDIN (UZB)
7. AKHMEDOV AKHMED (WKF-1)
7. MESKINI ALI (IRI)

*Seeded

Referees:			

Male Kumite -60 Kg - Round Robin (each against each)

Karate World Championships - Individual World Championships - Cairo 2025, 3894+XV8, Al Estad, Qesm Than Madinet Nasr, Cairo Governorate 4436020, EGY

Tatami

Pool
6/8

1	(*5) ARIFI O. (ALB)	#159 / 27.11	3	(*5) ARIFI O. (ALB)
2	(*6) GALLARDO J. (ARG)		2	
3	(*26) ALBASHER S. (KSA)	#160 / 27.11	1	(*4) ALY Z. (EGY)
4	(*4) ALY Z. (EGY)		2	
5	(*6) GALLARDO J. (ARG)	#163 / 27.11	0	(*26) ALBASHER S. (KSA)
6	(*26) ALBASHER S. (KSA)		5	
7	(*5) ARIFI O. (ALB)	#164 / 27.11	2	(*4) ALY Z. (EGY)
8	(*4) ALY Z. (EGY)		6	
9	(*5) ARIFI O. (ALB)	#167 / 27.11	6	(*26) ALBASHER S. (KSA)
10	(*26) ALBASHER S. (KSA)		12	
11	(*6) GALLARDO J. (ARG)	#168 / 27.11	3	(*4) ALY Z. (EGY)
12	(*4) ALY Z. (EGY)		5	

1. ALY ZYAD ELGHARIB (EGY)
2. ALBASHER SAUD (KSA)
3. ARIFI ORGES (ALB)
4. GALLARDO JUAN IGNACIO (ARG)

1. SAMDAN ERAY (TUR)
2. SELMANI ISLAM (KOS)
3. HASHIMOTO HIROMU (JPN)
3. XENOS CHRISTOS-STEFANOS (GRE)
5. SORDIA TSOTNE (GEO)
5. TURAKHONOV MEKHRIDDIN (UZB)
7. AKHMEDOV AKHMED (WKF-1)
7. MESKINI ALI (IRI)

*Seeded

Referees:			

Male Kumite -60 Kg - Round Robin (each against each)

Karate World Championships - Individual World Championships - Cairo 2025, 3894+XV8, Al Estad, Qesm Than Madinet Nasr, Cairo Governorate 4436020, EGY

Tatami

Pool

7/8

1	(*12) HSU L. (TPE)	#226 / 27.11	1	(*19) ALPYSBAY K. (KAZ)
2	(*19) ALPYSBAY K. (KAZ)		2	
3	(*7) SQUIRE D. (AUS)	#227 / 27.11	0	(*25) TORNACI E. (ROU)
4	(*25) TORNACI E. (ROU)		1	
5	(*19) ALPYSBAY K. (KAZ)		PTS	
6	(*7) SQUIRE D. (AUS)	#230 / 27.11	2	(*19) ALPYSBAY K. (KAZ)
7	(*12) HSU L. (TPE)		0	
8	(*25) TORNACI E. (ROU)	#231 / 27.11	0	(*25) TORNACI E. (ROU)
9	(*12) HSU L. (TPE)		3	
10	(*7) SQUIRE D. (AUS)	#234 / 27.11	0	(*7) SQUIRE D. (AUS)
11	(*19) ALPYSBAY K. (KAZ)		1	
12	(*25) TORNACI E. (ROU)	#235 / 27.11	1	(*25) TORNACI E. (ROU)

1. TORNACI ERHAN (ROU)
2. ALPYSBAY KAISAR (KAZ)
3. SQUIRE DECLAN (AUS)
4. HSU LI-WEI (TPE)

1. SAMDAN ERAY (TUR)
2. SELMANI ISLAM (KOS)
3. HASHIMOTO HIROMU (JPN)
3. XENOS CHRISTOS-STEFANOS (GRE)
5. SORDIA TSOTNE (GEO)
5. TURAKHONOV MEKHRIDDIN (UZB)
7. AKHMEDOV AKHMED (WKF-1)
7. MESKINI ALI (IRI)

*Seeded

















Referees:			

Male Kumite -60 Kg - Round Robin (each against each)

Karate World Championships - Individual World Championships - Cairo 2025, 3894+XV8, Al Estad, Qesm Than Madinet Nasr, Cairo Governorate 4436020, EGY

Tatami

Pool
8/8

1	 (*24) VESELI F. (MKD)	0	 (*27) MUEKTHONG S. (THA)
	#228 / 27.11		
2	 (*27) MUEKTHONG S. (THA)	1	
3	 (*28) AYAT M. (TUN)	2	 (*1) HASHIMOTO H. (JPN)
	#229 / 27.11		
4	 (*1) HASHIMOTO H. (JPN)	8	
	PTS		
5	 (*27) MUEKTHONG S. (THA)	3	 (*27) MUEKTHONG S. (THA)
	#232 / 27.11		
6	 (*28) AYAT M. (TUN)	1	
7	 (*24) VESELI F. (MKD)	2	 (*1) HASHIMOTO H. (JPN)
	#233 / 27.11		
8	 (*1) HASHIMOTO H. (JPN)	7	
9	 (*24) VESELI F. (MKD)	0	 (*28) AYAT M. (TUN)
	#236 / 27.11		
10	 (*28) AYAT M. (TUN)	2	
11	 (*27) MUEKTHONG S. (THA)	0	
	#237 / 27.11		
12	 (*1) HASHIMOTO H. (JPN)	0	

1. HASHIMOTO HIROMU (JPN)
2. MUEKTHONG SIWAKON (THA)
3. AYAT MOHAMED (TUN)
4. VESELI FAHIK (MKD)

1. SAMDAN ERAY (TUR)
2. SELMANI ISLAM (KOS)
3. HASHIMOTO HIROMU (JPN)
3. XENOS CHRISTOS-STEFANOS (GRE)
5. SORDIA TSOTNE (GEO)
5. TURAKHONOV MEKHRIDDIN (UZB)
7. AKHMEDOV AKHMED (WKF-1)
7. MESKINI ALI (IRI)

*Seeded

Referees:			

Pool winner-Male Kumite -60 Kg

Karate World Championships - Individual World Championships - Cairo 2025, 3894+XV8, Al Estad, Qesm Than Madinet Nasr, Cairo Governorate 4436020, EGY

Tatami

Pool
1/1

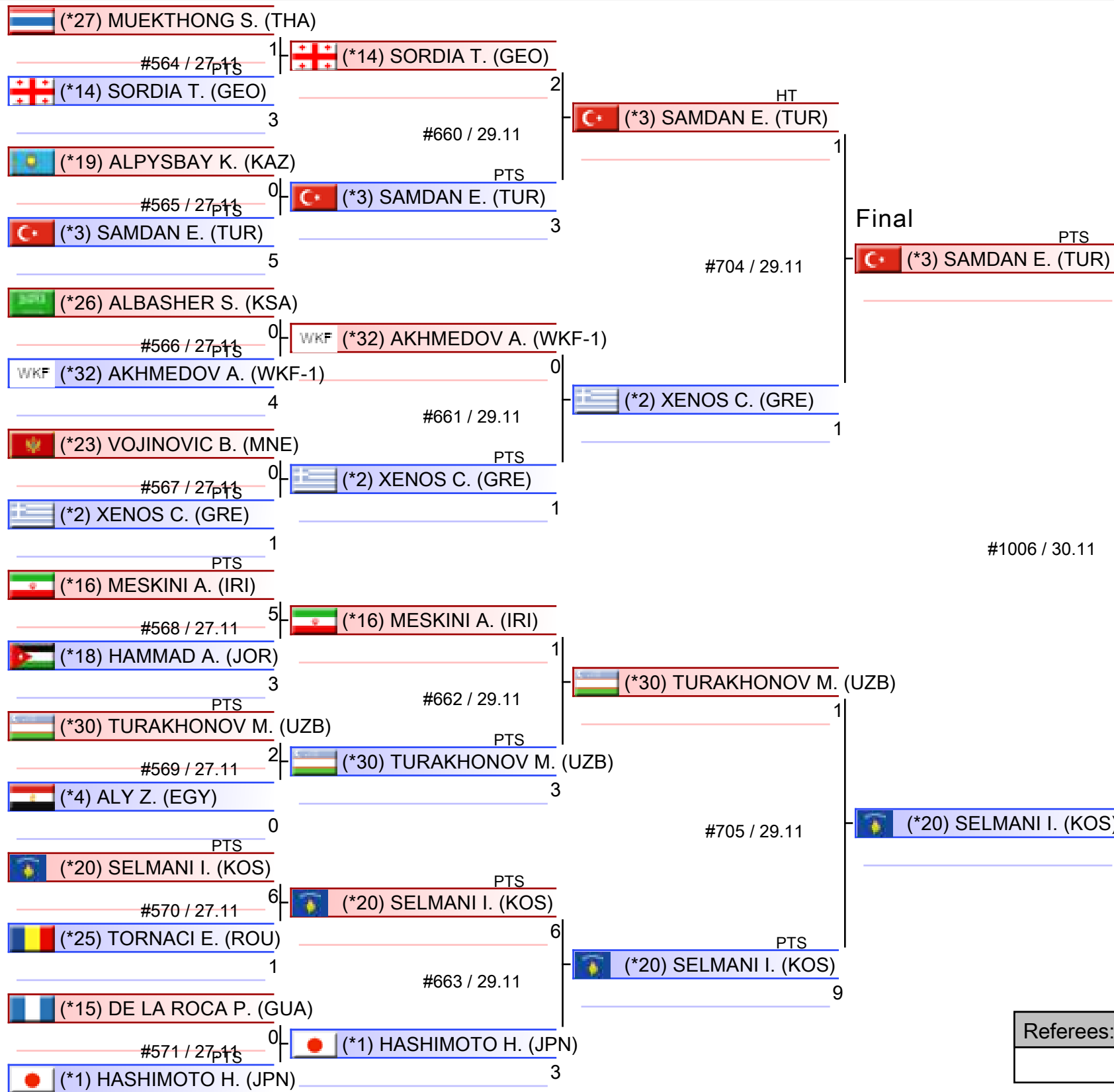

1. SAMDAN ERAY (TUR)
2. SELMANI ISLAM (KOS)
3. HASHIMOTO HIROMU (JPN)
3. XENOS CHRISTOS-STEFANOS (GRE)
5. SORDIA TSOTNE (GEO)
5. TURAKHONOV MEKHRIDDIN (UZB)
7. AKHMEDOV AKHMED (WKF-1)
7. MESKINI ALI (IRI)

*Seeded

Referees:			

Male Kumite -60 Kg

Karate World Championships - Individual World Championships - Cairo 2025

(c)sportdata GmbH & Co KG 2000-2025 (2025-12-02 21:54) v 11.0.0 build 2 (2025-11-22 17:48 CET) License: SDIL TVG ODF (expire 2026-01-23)

Tatami

Pool
1,2,3,4,5,6,7,8

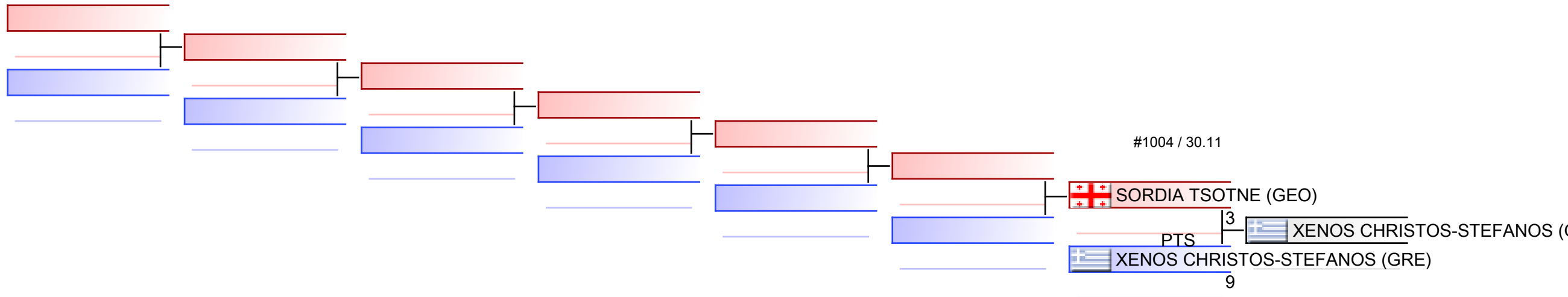

REPECHAGE: (1,2,3,4,5,6,7,8)

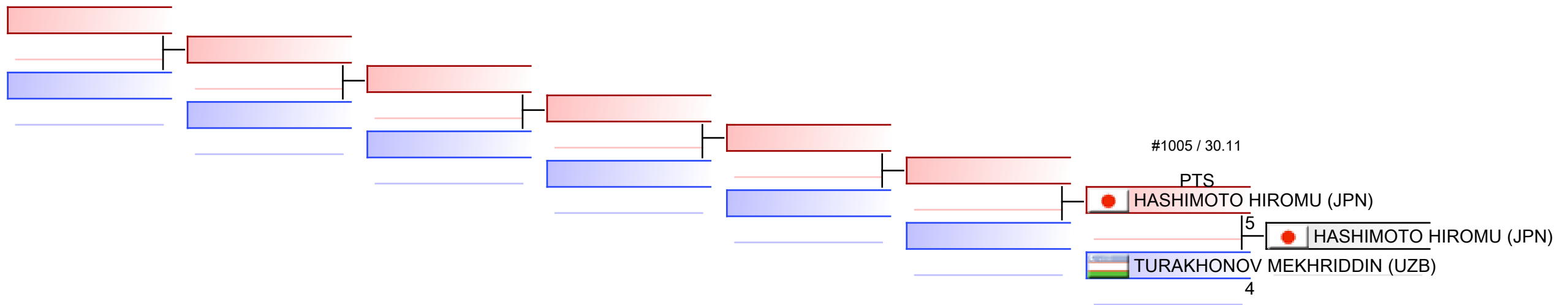

Referees:							
-----------	--	--	--	--	--	--	--



Karate World Championships - Individual World
Championships - Cairo 2025 - 2025-11-27



Official Results

Male Kumite -60 Kg			
1	SAMDAN ERAY		TUR - TURKIYE
2	SELMANI ISLAM		KOS - KOSOVO
3	HASHIMOTO HIROMU		JPN - JAPAN
3	XENOS CHRISTOS-STEFANOS		GRE - GREECE
5	SORDIA TSOTNE		GEO - GEORGIA
5	TURAKHONOV MEKHRIDDIN		UZB - UZBEKISTAN
7	AKHMEDOV AKHMED		WKF-1 - WKF-1
7	MESKINI ALI		IRI - ISLAMIC REPUBLIC OF IRAN

MALE KUMITE -67 KG



Karate World Championships - Individual World Cha ..



ENTRIES BY WEIGHT CATEGORY

Male Kumite -67 Kg

As of 2 DEC 2025

Code	ID	Gender	Name	Seeding
ALG	ALG02552	M	HELASSA AYOUB ANIS	5
AUS	AUS2322	M	ATTRIDGE RORY	6
AZE	AZE02341	M	RZAZADE NURAN	7
BRA	BRA299	M	FIGUEIRA VINICIUS	4
CAN	CAN02732	M	EBRAHEEM KARIM	8
CHI	CHI2097	M	FREIRE FUENTES TOMAS	9
EGY	EGY319	M	ELSAWY ALI	11
FRA	FRA2370	M	SALMI YOUNESSE	12
GER	GER2584	M	OEZDEMIR MUHAMMED	13
GRE	GRE02321	M	BALLOTIS GEORGIOS	14
GUA	GUA2005	M	CHACON CARLOS JOSE	15
HKG	HKG2139	M	CHENG HUI PAN	16
IRI	IRI03111	M	BORZOOEICHAGHAGOLANI AMIRREZA	17
ITA	ITA329	M	MARESCA LUCA	18
JOR	JOR2159	M	GHAITH AFEEF	19
JPN	JPN2077	M	KOZAKI YUGO	2
KAZ	KAZ215	M	AMIRALI DIDAR	20
KSA	KSA2058	M	ALASSIRI MOHAMMED	27
MAR	MAR2271	M	OUBAYA SAID	1
MDA	MDA02267	M	CAPMOALE ALEXANDR	21
MNE	MNE342	M	DULOVIC NENAD	22
NZL	NZL02439	M	TAKEUCHI REO	23
POL	POL2485	M	DZIUDA DOMINIK	24
POR	POR2170	M	MENDES JOAQUIM	25
RSA	RSA2068	M	WILLIAMS JODY	29
RWA	RWA2062	M	NTWARI FISTON	26
SRB	SRB191	M	JOKSIC STEFAN	28
TPE	TPE2046	M	SHIH CHENG-CHUNG	10
TUR	TUR2050	M	OZER OMER ABDURRAHIM	3
USA	USA02564	M	AKDE EVANGELOS	30
UZB	UZB02714	M	RASHIDOV ABDUL VAKHKHOB	31
WKF-1	RUS2340	M	OGANNISIAN IURIK	32



















Male Kumite -67 Kg - Round Robin (each against each)

Karate World Championships - Individual World Championships - Cairo 2025, 3894+XV8, Al Estad, Qesm Than Madinet Nasr, Cairo Governorate 4436020, EGY

Tatami

Pool

1/8

1	 (*19) GHAITH A. (JOR)		
	#37 / 27.11	7	 (*19) GHAITH A. (JOR)
2	 (*26) NTWARI F. (RWA)		
		0	
3	 (*15) CHACON C. (GUA)		
	#38 / 27.11	2	 (*12) SALMI Y. (FRA)
4	 (*12) SALMI Y. (FRA)		
		5	
5	 (*26) NTWARI F. (RWA)		
	#41 / 27.11	3	 (*15) CHACON C. (GUA)
6	 (*15) CHACON C. (GUA)		
	PTS	6	
7	 (*19) GHAITH A. (JOR)		
	#42 / 27.11	2	 (*19) GHAITH A. (JOR)
8	 (*12) SALMI Y. (FRA)		
	PTS	1	
9	 (*19) GHAITH A. (JOR)		
	#45 / 27.11	5	 (*19) GHAITH A. (JOR)
10	 (*15) CHACON C. (GUA)		
		4	
11	 (*26) NTWARI F. (RWA)		
	#46 / 27.11	0	 (*12) SALMI Y. (FRA)
12	 (*12) SALMI Y. (FRA)		
		2	

1. GHAITH AFEEF (JOR)
2. SALMI YOUNESSE (FRA)
3. CHACON CARLOS JOSE (GUA)
4. NTWARI FISTON (RWA)

1. GHAITH AFEEF (JOR)
2. OUBAYA SAID (MAR)
3. AMIRALI DIDAR (KAZ)
3. RASHIDOV ABDUL VAKHKHOB (UZB)
5. FREIRE FUENTES TOMAS (CHI)
5. BALIOTIS GEORGIOS (GRE)
7. OGANNISIAN IURIK (WKF-1)
7. HELASSA AYOUB ANIS (ALG)

*Seeded

Referees:			

Male Kumite -67 Kg - Round Robin (each against each)

Karate World Championships - Individual World Championships - Cairo 2025, 3894+XV8, Al Estad, Qesm Than Madinet Nasr, Cairo Governorate 4436020, EGY

Tatami

Pool
2/8

1	(*20) AMIRALI D. (KAZ)	#39 / 27.11	1	(*13) OEZDEMIR M. (GER)
2	(*13) OEZDEMIR M. (GER)		2	
3	(*29) WILLIAMS J. (RSA)	#40 / 27.11	3	(*3) OZER O. (TUR)
4	(*3) OZER O. (TUR)		4	
5	(*13) OEZDEMIR M. (GER)		PTS	
6	(*29) WILLIAMS J. (RSA)	#43 / 27.11	5	(*13) OEZDEMIR M. (GER)
7	(*20) AMIRALI D. (KAZ)		PTS	
8	(*3) OZER O. (TUR)	#44 / 27.11	2	(*20) AMIRALI D. (KAZ)
9	(*20) AMIRALI D. (KAZ)		KI	
10	(*29) WILLIAMS J. (RSA)	#47 / 27.11	7	(*20) AMIRALI D. (KAZ)
11	(*13) OEZDEMIR M. (GER)		5	(*3) OZER O. (TUR)
12	(*3) OZER O. (TUR)	#48 / 27.11	5	

1. OEZDEMIR MUHAMMED (GER)
2. AMIRALI DIDAR (KAZ)
3. OZER OMER ABDURRAHIM (TUR)
4. WILLIAMS JODY (RSA)

1. GHAITH AFEEF (JOR)
2. OUBAYA SAID (MAR)
3. AMIRALI DIDAR (KAZ)
3. RASHIDOV ABDUL VAKHKHOB (UZB)
5. FREIRE FUENTES TOMAS (CHI)
5. BALIOTIS GEORGIOS (GRE)
7. OGANNISIAN IURIK (WKF-1)
7. HELASSA AYOUB ANIS (ALG)

*Seeded

Referees:			

Male Kumite -67 Kg - Round Robin (each against each)

Karate World Championships - Individual World Championships - Cairo 2025, 3894+XV8, Al Estad, Qesm Than Madinet Nasr, Cairo Governorate 4436020, EGY

Tatami

Pool

3/8

1	(*22) DULOVIC N. (MNE)	
	#109 / 27.11	2 (*25) MENDES J. (POR)
2	(*25) MENDES J. (POR)	
	2	
	HA	
3	(*31) RASHIDOV A. (UZB)	
	#110 / 27.11	7 (*31) RASHIDOV A. (UZB)
4	(*23) TAKEUCHI R. (NZL)	
	3	
5	(*25) MENDES J. (POR)	
	#113 / 27.11	0 (*31) RASHIDOV A. (UZB)
6	(*31) RASHIDOV A. (UZB)	
	8	
	PTS	
7	(*22) DULOVIC N. (MNE)	
	#114 / 27.11	7 (*22) DULOVIC N. (MNE)
8	(*23) TAKEUCHI R. (NZL)	
	3	
9	(*22) DULOVIC N. (MNE)	
	#117 / 27.11	1 (*31) RASHIDOV A. (UZB)
10	(*31) RASHIDOV A. (UZB)	
	5	
	PTS	
11	(*25) MENDES J. (POR)	
	#118 / 27.11	3 (*25) MENDES J. (POR)
12	(*23) TAKEUCHI R. (NZL)	
	1	

1. RASHIDOV ABDUL VAKHKHOB (UZB)
2. MENDES JOAQUIM (POR)
3. DULOVIC NENAD (MNE)
4. TAKEUCHI REO (NZL)

1. GHAITH AFEEF (JOR)
2. OUBAYA SAID (MAR)
3. AMIRALI DIDAR (KAZ)
3. RASHIDOV ABDUL VAKHKHOB (UZB)
5. FREIRE FUENTES TOMAS (CHI)
5. BALIOTIS GEORGIOS (GRE)
7. OGANNISIAN IURIK (WKF-1)
7. HELASSA AYOUB ANIS (ALG)

*Seeded

Referees:			

Male Kumite -67 Kg - Round Robin (each against each)

Karate World Championships - Individual World Championships - Cairo 2025, 3894+XV8, Al Estad, Qesm Than Madinet Nasr, Cairo Governorate 4436020, EGY

Tatami

Pool

4/8

1	(*24) DZIUDA D. (POL)	0	(*32) OGANNISIAN I. (WKF-1)
	#111 / 27.11		
2	(*32) OGANNISIAN I. (WKF-1)	1	
3	(*8) EBRAHEEM K. (CAN)	4	(*2) KOZAKI Y. (JPN)
	#112 / 27.11		
4	(*2) KOZAKI Y. (JPN)	5	
	PTS		
5	(*32) OGANNISIAN I. (WKF-1)	4	(*32) OGANNISIAN I. (WKF-1)
	#115 / 27.11		
6	(*8) EBRAHEEM K. (CAN)	3	
7	(*24) DZIUDA D. (POL)	0	(*2) KOZAKI Y. (JPN)
	#116 / 27.11		
8	(*2) KOZAKI Y. (JPN)	4	
	PTS		
9	(*24) DZIUDA D. (POL)	4	(*24) DZIUDA D. (POL)
	#119 / 27.11		
10	(*8) EBRAHEEM K. (CAN)	2	
	SEN		
11	(*32) OGANNISIAN I. (WKF-1)	4	(*32) OGANNISIAN I. (WKF-1)
	#120 / 27.11		
12	(*2) KOZAKI Y. (JPN)	4	

1. OGANNISIAN IURIK (WKF-1)
2. KOZAKI YUGO (JPN)
3. DZIUDA DOMINIK (POL)
4. EBRAHEEM KARIM (CAN)

1. GHAITH AFEEF (JOR)
2. OUBAYA SAID (MAR)
3. AMIRALI DIDAR (KAZ)
3. RASHIDOV ABDUL VAKHKHOB (UZB)
5. FREIRE FUENTES TOMAS (CHI)
5. BALIOTIS GEORGIOS (GRE)
7. OGANNISIAN IURIK (WKF-1)
7. HELASSA AYOUB ANIS (ALG)

*Seeded

Referees:			

Male Kumite -67 Kg - Round Robin (each against each)

Karate World Championships - Individual World Championships - Cairo 2025, 3894+XV8, Al Estad, Qesm Than Madinet Nasr, Cairo Governorate 4436020, EGY

Tatami

Pool

5/8

1	(*6) ATTRIDGE R. (AUS)	#181 / 27.11	1	(*9) FREIRE FUENTES T. (CHI)
2	(*9) FREIRE FUENTES T. (CHI)		3	
3	(*7) RZAZADE N. (AZE)	#182 / 27.11	1	(*27) ALASSIRI M. (KSA)
4	(*27) ALASSIRI M. (KSA)		2	
5	(*9) FREIRE FUENTES T. (CHI)	#185 / 27.11	1	(*7) RZAZADE N. (AZE)
6	(*7) RZAZADE N. (AZE)		5	
7	(*6) ATTRIDGE R. (AUS)	#186 / 27.11	0	(*27) ALASSIRI M. (KSA)
8	(*27) ALASSIRI M. (KSA)		6	
9	(*6) ATTRIDGE R. (AUS)	PTS	8	(*6) ATTRIDGE R. (AUS)
10	(*7) RZAZADE N. (AZE)		6	
11	(*9) FREIRE FUENTES T. (CHI)	PTS	4	(*9) FREIRE FUENTES T. (CHI)
12	(*27) ALASSIRI M. (KSA)	#190 / 27.11	1	

1. FREIRE FUENTES TOMAS (CHI)
2. ALASSIRI MOHAMMED (KSA)
3. ATTRIDGE RORY (AUS)
4. RZAZADE NURAN (AZE)

1. GHAITH AFEEF (JOR)
2. OUBAYA SAID (MAR)
3. AMIRALI DIDAR (KAZ)
3. RASHIDOV ABDUL VAKHKHOB (UZB)
5. FREIRE FUENTES TOMAS (CHI)
5. BALIOTIS GEORGIOS (GRE)
7. OGANNISIAN IURIK (WKF-1)
7. HELASSA AYOUB ANIS (ALG)

*Seeded

Referees:			

Male Kumite -67 Kg - Round Robin (each against each)

Karate World Championships - Individual World Championships - Cairo 2025, 3894+XV8, Al Estad, Qesm Than Madinet Nasr, Cairo Governorate 4436020, EGY

Tatami

Pool
6/8

1	(*10) SHIH C. (TPE)	
	#183 / 27.11	2 (*5) HELASSA A. (ALG)
2	(*5) HELASSA A. (ALG)	6
	PTS	
3	(*18) MARESCA L. (ITA)	
	#184 / 27.11	5 (*18) MARESCA L. (ITA)
4	(*4) FIGUEIRA V. (BRA)	0
	PTS	
5	(*5) HELASSA A. (ALG)	
	#187 / 27.11	3 (*5) HELASSA A. (ALG)
6	(*18) MARESCA L. (ITA)	3
	SEN	
7	(*10) SHIH C. (TPE)	
	#188 / 27.11	6 (*10) SHIH C. (TPE)
8	(*4) FIGUEIRA V. (BRA)	6
	SEN	
9	(*10) SHIH C. (TPE)	
	#191 / 27.11	2 (*18) MARESCA L. (ITA)
10	(*18) MARESCA L. (ITA)	2
	SEN	
11	(*5) HELASSA A. (ALG)	
	#192 / 27.11	2 (*4) FIGUEIRA V. (BRA)
12	(*4) FIGUEIRA V. (BRA)	3

1. HELASSA AYOUB ANIS (ALG)
2. MARESCA LUCA (ITA)
3. SHIH CHENG-CHUNG (TPE)
4. FIGUEIRA VINICIUS (BRA)

1. GHAITH AFEEF (JOR)
2. OUBAYA SAID (MAR)
3. AMIRALI DIDAR (KAZ)
3. RASHIDOV ABDUL VAKHKHOB (UZB)
5. FREIRE FUENTES TOMAS (CHI)
5. BALIOTIS GEORGIOS (GRE)
7. OGANNISIAN IURIK (WKF-1)
7. HELASSA AYOUB ANIS (ALG)

*Seeded

Referees:			













Male Kumite -67 Kg - Round Robin (each against each)

Karate World Championships - Individual World Championships - Cairo 2025, 3894+XV8, Al Estad, Qesm Than Madinet Nasr, Cairo Governorate 4436020, EGY

Tatami

Pool

7/8

1	 (*16) CHENG H. (HKG)	
	#247 / 27.11	
2	 (*30) AKDE E. (USA)	
3	 (*14) BALIOTIS G. (GRE)	
4	 (*11) ELSAWY A. (EGY)	0
	#248 / 27.11	 (*11) ELSAWY A. (EGY)
5	 (*30) AKDE E. (USA)	
	#251 / 27.11	
6	 (*14) BALIOTIS G. (GRE)	
7	 (*16) CHENG H. (HKG)	
	#252 / 27.11	1
8	 (*11) ELSAWY A. (EGY)	4
9	 (*16) CHENG H. (HKG)	
	#255 / 27.11	3
10	 (*14) BALIOTIS G. (GRE)	9
11	 (*30) AKDE E. (USA)	
	#256 / 27.11	
12	 (*11) ELSAWY A. (EGY)	

1. ELSAWY ALI (EGY)
2. BALIOTIS GEORGIOS (GRE)
3. CHENG HUI PAN (HKG)
4. AKDE EVANGELOS (USA)

1. GHAITH AFEEF (JOR)
2. OUBAYA SAID (MAR)
3. AMIRALI DIDAR (KAZ)
3. RASHIDOV ABDUL VAKHKHOB (UZB)
5. FREIRE FUENTES TOMAS (CHI)
5. BALIOTIS GEORGIOS (GRE)
7. OGANNISIAN IURIK (WKF-1)
7. HELASSA AYOUB ANIS (ALG)

*Seeded

Referees:			

Male Kumite -67 Kg - Round Robin (each against each)

Karate World Championships - Individual World Championships - Cairo 2025, 3894+XV8, Al Estad, Qesm Than Madinet Nasr, Cairo Governorate 4436020, EGY

Tatami

Pool
8/8

1	(*28) JOKSIC S. (SRB)	#249 / 27.11	3	(*28) JOKSIC S. (SRB)
2	(*21) CAPMOALE A. (MDA)		2	
3	(*17) BORZOOEICHAGHAGOLANI A. (IRI)	#250 / 27.11	1	(*1) OUBAYA S. (MAR)
4	(*1) OUBAYA S. (MAR)		9	
5	(*21) CAPMOALE A. (MDA)	#253 / 27.11	0	(*17) BORZOOEICHAGHAGOLANI A. (IRI)
6	(*17) BORZOOEICHAGHAGOLANI A. (IRI)		7	
7	(*28) JOKSIC S. (SRB)	#254 / 27.11	0	(*1) OUBAYA S. (MAR)
8	(*1) OUBAYA S. (MAR)		3	
9	(*28) JOKSIC S. (SRB)	PTS	2	(*28) JOKSIC S. (SRB)
10	(*17) BORZOOEICHAGHAGOLANI A. (IRI)	#257 / 27.11	1	
11	(*21) CAPMOALE A. (MDA)	#258 / 27.11	0	(*1) OUBAYA S. (MAR)
12	(*1) OUBAYA S. (MAR)		4	

1. OUBAYA SAID (MAR)
2. JOKSIC STEFAN (SRB)
3. BORZOOEICHAGHAGOLANI AMIRREZA (IRI)
4. CAPMOALE ALEXANDR (MDA)

1. GHAITH AFEEF (JOR)
2. OUBAYA SAID (MAR)
3. AMIRALI DIDAR (KAZ)
3. RASHIDOV ABDUL VAKHKHOB (UZB)
5. FREIRE FUENTES TOMAS (CHI)
5. BALIOTIS GEORGIOS (GRE)
7. OGANNISIAN IURIK (WKF-1)
7. HELASSA AYOUB ANIS (ALG)

*Seeded

Referees:			

Pool winner-Male Kumite -67 Kg

Karate World Championships - Individual World Championships - Cairo 2025, 3894+XV8, Al Estad, Qesm Than Madinet Nasr, Cairo Governorate 4436020, EGY

Tatami

Pool

1/1

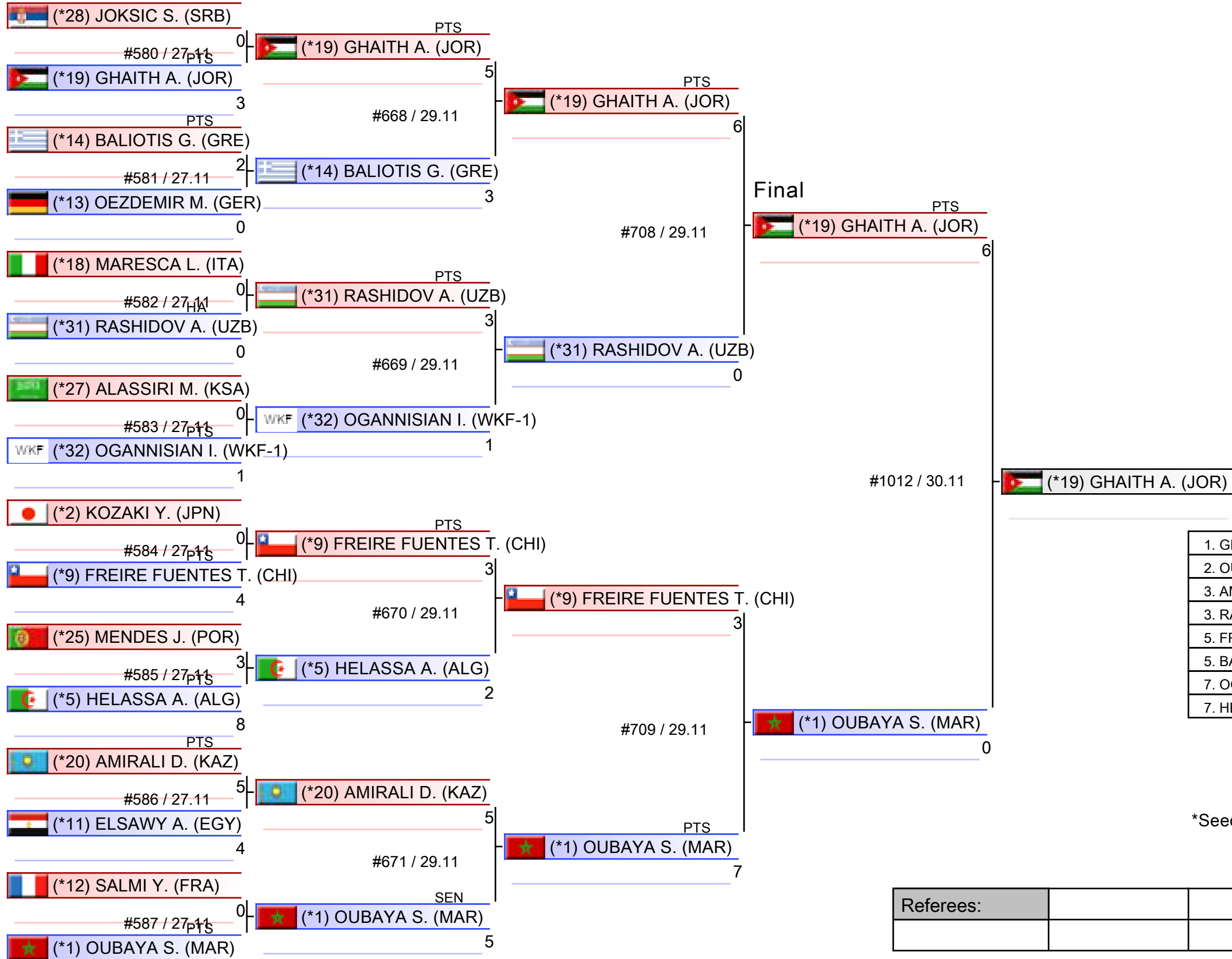

Referees:			

Male Kumite -67 Kg

Karate World Championships - Individual World Championships - Cairo 2025

(c)sportdata GmbH & Co KG 2000-2025 (2025-12-02 21:54) v 11.0.0 build 2 (2025-11-22 17:48 CET) License: SDIL TVG ODF (expire 2026-01-23)

Tatami

Pool
1,2,3,4,5,6,7,8

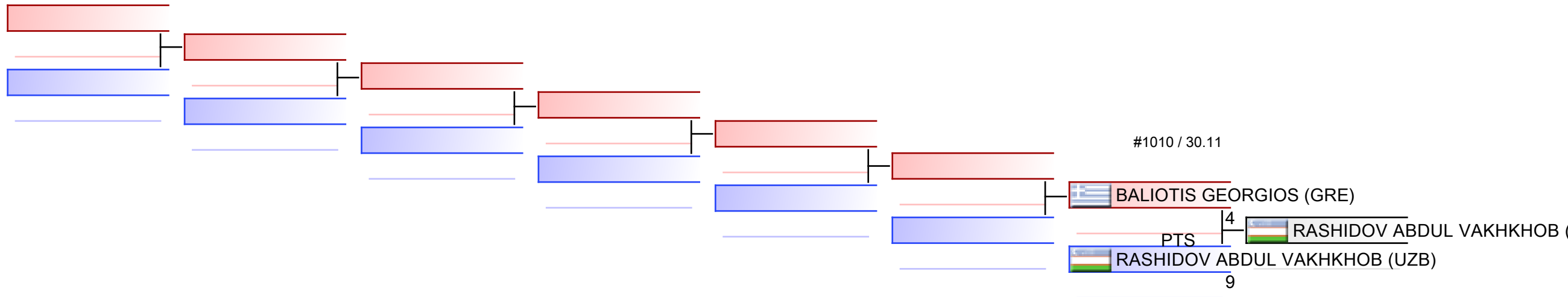

REPECHAGE: (1,2,3,4,5,6,7,8)

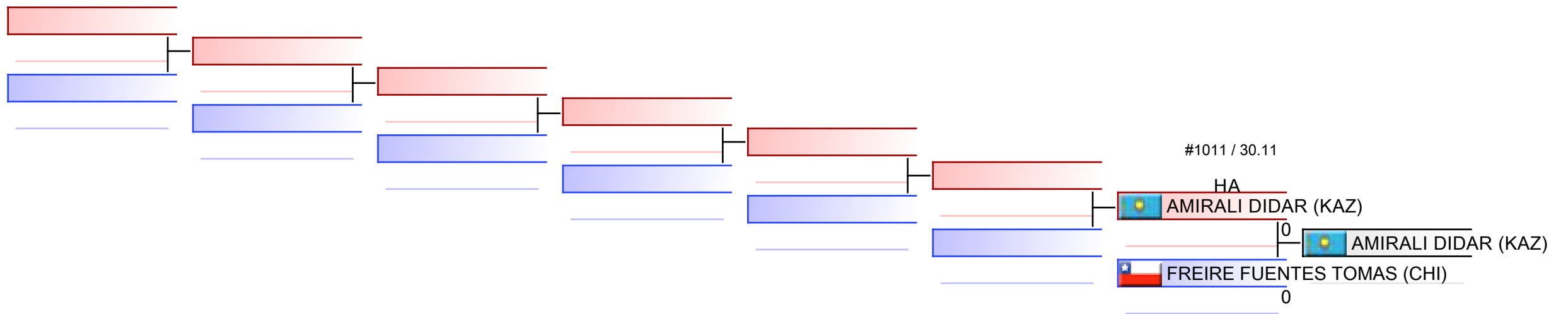

Referees:							
-----------	--	--	--	--	--	--	--



Karate World Championships - Individual World
Championships - Cairo 2025 - 2025-11-27



Official Results

Male Kumite -67 Kg			
1	GHAITH AFEEF		JOR - JORDAN
2	OUBAYA SAID		MAR - MOROCCO
3	AMIRALI DIDAR		KAZ - KAZAKHSTAN
3	RASHIDOV ABDUL VAKHKHOB		UZB - UZBEKISTAN
5	FREIRE FUENTES TOMAS		CHI - CHILE
5	BALLOTIS GEORGIOS		GRE - GREECE
7	OGANNISIAN IURIK		WKF-1 - WKF-1
7	HELASSA AYOUB ANIS		ALG - ALGERIA

MALE KUMITE -75 KG



Karate World Championships - Individual World Cha ..



ENTRIES BY WEIGHT CATEGORY

Male Kumite -75 Kg

As of 2 DEC 2025

Code	ID	Gender	Name	Seeding
ALG	ALG04187	M	ZAID OUSSAMA	5
ANG	ANG02023	M	LOPES NARIO	6
ARM	ARM2142	M	HARUTYUNYAN SUREN	7
AUS	AUS290	M	DURHAM MITCHELL	8
BEL	BEL2033	M	MAHAUDEN QUENTIN	9
CHI	CHI2036	M	RODRIGUEZ FUENTES MATIAS	10
EGY	EGY2218	M	ABDELAZIZ ABDALLA MAMDUH	1
FRA	FRA2231	M	BERTHON ENZO	3
GRE	GRE004060	M	ZYGOURIS KONSTANTINOS	11
HUN	HUN258	M	HARSPATAKI KAROLY GABOR	12
IRI	IRI2346	M	NEMATI MORTEZA	13
ITA	ITA2510	M	DE VIVO DANIELE	14
JOR	JOR02338	M	AL NAJJAR SAEED	16
JPN	JPN2313	M	SAKIYAMA YUSEI	15
KAZ	KAZ2028	M	AZHIKANOV NURKANAT	2
KOS	KOS2378	M	MALIQI BETIM	17
KSA	KSA2191	M	ALZAHIRANI SULTAN	25
LBA	LBA02377	M	ABUDABOUS MOHAMED	18
MAR	MAR003566	M	SAM HAMZA	21
MEX	MEX294	M	VILLARREAL AVILA CARLOS JULIAN	19
MNE	MNE2045	M	MIKULIC NEMANJA	20
NED	NED02684	M	FRANKEN RICARDO	22
NZL	NZL2087	M	SOMERVILLE LOGAN	23
POR	POR2177	M	DUARTE TIAGO	24
TUN	TUN02328	M	TLILI AHMED RAYANE	26
TUR	TUR2674	M	YURUR OMER FARUK	4
UKR	UKR2204	M	ZAPLITNYI ANDRII	27
USA	USA173	M	SCOTT THOMAS	28
UZB	UZB2157	M	MUKHAMMADIYEV KUVONCHBEK	29
WKF-1	RUS2433	M	SHARAFUTDINOV ERNEST	30
WKF-2	BLR2090	M	NHUYEN DEVID	31



















Male Kumite -75 Kg - Round Robin (each against each)

Karate World Championships - Individual World Championships - Cairo 2025, 3894+XV8, Al Estad, Qesm Than Madinet Nasr, Cairo Governorate 4436020, EGY

Tatami

Pool

1/8

1	 (*6) LOPES N. (ANG)	
	#61 / 27.11	3  (*27) ZAPLITNYI A. (UKR)
2	 (*27) ZAPLITNYI A. (UKR)	
	4	
	PTS	
3	 (*24) DUARTE T. (POR)	
	#62 / 27.11	4  (*24) DUARTE T. (POR)
4	 (*23) SOMERVILLE L. (NZL)	
	0	
	PTS	
5	 (*27) ZAPLITNYI A. (UKR)	
	#65 / 27.11	3  (*27) ZAPLITNYI A. (UKR)
6	 (*24) DUARTE T. (POR)	
	0	
	PTS	
7	 (*6) LOPES N. (ANG)	
	#66 / 27.11	5  (*6) LOPES N. (ANG)
8	 (*23) SOMERVILLE L. (NZL)	
	1	
	PTS	
9	 (*6) LOPES N. (ANG)	
	#69 / 27.11	5  (*24) DUARTE T. (POR)
10	 (*24) DUARTE T. (POR)	
	6	
	PTS	
11	 (*27) ZAPLITNYI A. (UKR)	
	#70 / 27.11	3  (*27) ZAPLITNYI A. (UKR)
12	 (*23) SOMERVILLE L. (NZL)	
	2	

1. ZAPLITNYI ANDRII (UKR)
2. DUARTE TIAGO (POR)
3. LOPES NARIO (ANG)
4. SOMERVILLE LOGAN (NZL)

1. ABDELAZIZ ABDALLA MAMDUH (EGY)
2. ZAPLITNYI ANDRII (UKR)
3. HARUTYUNYAN SUREN (ARM)
3. SHARAFUTDINOV ERNEST (WKF-1)
5. BERTHON ENZO (FRA)
5. SCOTT THOMAS (USA)
7. AZHIKANOV NURKANAT (KAZ)
7. SAM HAMZA (MAR)

*Seeded

Referees:			















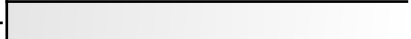

Male Kumite -75 Kg - Round Robin (each against each)

Karate World Championships - Individual World Championships - Cairo 2025, 3894+XV8, Al Estad, Qesm Than Madinet Nasr, Cairo Governorate 4436020, EGY

Tatami

Pool

2/8

1	 (*5) ZAID O. (ALG)	
	#63 / 27.11	4  (*5) ZAID O. (ALG)
2	 (*31) NHUYEN D. (WKF-2)	
	PTS	3
3	 (*17) MALIQI B. (KOS)	
	#64 / 27.11	4  (*17) MALIQI B. (KOS)
4	 (*3) BERTHON E. (FRA)	
	PTS	3
5	 (*31) NHUYEN D. (WKF-2)	
	#67 / 27.11	0 
6	 (*17) MALIQI B. (KOS)	
	PTS	0
7	 (*5) ZAID O. (ALG)	
	#68 / 27.11	0  (*3) BERTHON E. (FRA)
8	 (*3) BERTHON E. (FRA)	
	PTS	2
9	 (*5) ZAID O. (ALG)	
	#71 / 27.11	1  (*5) ZAID O. (ALG)
10	 (*17) MALIQI B. (KOS)	
	PTS	0
11	 (*31) NHUYEN D. (WKF-2)	
	#72 / 27.11	2  (*3) BERTHON E. (FRA)
12	 (*3) BERTHON E. (FRA)	
	PTS	7

1. BERTHON ENZO (FRA)
2. ZAID OUSSAMA (ALG)
3. MALIQI BETIM (KOS)
4. NHUYEN DEVID (WKF-2)

1. ABDELAZIZ ABDALLA MAMDUH (EGY)
2. ZAPLITNYI ANDRII (UKR)
3. HARUTYUNYAN SUREN (ARM)
3. SHARAFUTDINOV ERNEST (WKF-1)
5. BERTHON ENZO (FRA)
5. SCOTT THOMAS (USA)
7. AZHIKANOV NURKANAT (KAZ)
7. SAM HAMZA (MAR)

*Seeded

Referees:			

Male Kumite -75 Kg - Round Robin (each against each)

Karate World Championships - Individual World Championships - Cairo 2025, 3894+XV8, Al Estad, Qesm Than Madinet Nasr, Cairo Governorate 4436020, EGY

Tatami

Pool

3/8

1	(*7) HARUTYUNYAN S. (ARM)	4	(*7) HARUTYUNYAN S. (ARM)
	#133 / 27.11		
2	(*29) MUKHAMMADIYEV K. (UZB)	2	
3	(*19) VILLARREAL AVILA C. (MEX)	2	(*30) SHARAFUTDINOV E. (WKF-1)
	#134 / 27.11		
4	(*30) SHARAFUTDINOV E. (WKF-1)	5	
	PTS		
5	(*29) MUKHAMMADIYEV K. (UZB)	7	(*29) MUKHAMMADIYEV K. (UZB)
	#137 / 27.11		
6	(*19) VILLARREAL AVILA C. (MEX)	1	
7	(*7) HARUTYUNYAN S. (ARM)	0	(*30) SHARAFUTDINOV E. (WKF-1)
	#138 / 27.11		
8	(*30) SHARAFUTDINOV E. (WKF-1)	5	
	PTS		
9	(*7) HARUTYUNYAN S. (ARM)	6	(*7) HARUTYUNYAN S. (ARM)
	#141 / 27.11		
10	(*19) VILLARREAL AVILA C. (MEX)	5	
11	(*29) MUKHAMMADIYEV K. (UZB)	2	(*30) SHARAFUTDINOV E. (WKF-1)
	#142 / 27.11		
12	(*30) SHARAFUTDINOV E. (WKF-1)	3	

1. SHARAFUTDINOV ERNEST (WKF-1)
2. HARUTYUNYAN SUREN (ARM)
3. MUKHAMMADIYEV KUVONCHBEK (UZB)
4. VILLARREAL AVILA CARLOS JULIAN (MEX)

1. ABDELAZIZ ABDALLA MAMDUH (EGY)
2. ZAPLITNYI ANDRII (UKR)
3. HARUTYUNYAN SUREN (ARM)
3. SHARAFUTDINOV ERNEST (WKF-1)
5. BERTHON ENZO (FRA)
5. SCOTT THOMAS (USA)
7. AZHIKANOV NURKANAT (KAZ)
7. SAM HAMZA (MAR)

*Seeded

Referees:			

















Male Kumite -75 Kg - Round Robin (each against each)

Karate World Championships - Individual World Championships - Cairo 2025, 3894+XV8, Al Estad, Qesm Than Madinet Nasr, Cairo Governorate 4436020, EGY

Tatami

Pool

4/8

1	 (*13) NEMATI M. (IRI)	
	#135 / 27.11	1  (*13) NEMATI M. (IRI)
2	 (*26) TLILI A. (TUN)	0
3	 (*9) MAHAUDEN Q. (BEL)	
	#136 / 27.11	0  (*2) AZHIKANOV N. (KAZ)
4	 (*2) AZHIKANOV N. (KAZ)	1
5	 (*26) TLILI A. (TUN)	
	#139 / 27.11	6  (*9) MAHAUDEN Q. (BEL)
6	 (*9) MAHAUDEN Q. (BEL)	10
7	 (*13) NEMATI M. (IRI)	
	#140 / 27.11	1  (*2) AZHIKANOV N. (KAZ)
8	 (*2) AZHIKANOV N. (KAZ)	2
	PTS	
9	 (*13) NEMATI M. (IRI)	
	#143 / 27.11	8  (*13) NEMATI M. (IRI)
10	 (*9) MAHAUDEN Q. (BEL)	1
11	 (*26) TLILI A. (TUN)	
	#144 / 27.11	0  (*2) AZHIKANOV N. (KAZ)
12	 (*2) AZHIKANOV N. (KAZ)	4

1. AZHIKANOV NURKANAT (KAZ)
2. NEMATI MORTEZA (IRI)
3. MAHAUDEN QUENTIN (BEL)
4. TLILI AHMED RAYANE (TUN)

1. ABDELAZIZ ABDALLA MAMDUH (EGY)
2. ZAPLITNYI ANDRII (UKR)
3. HARUTYUNYAN SUREN (ARM)
3. SHARAFUTDINOV ERNEST (WKF-1)
5. BERTHON ENZO (FRA)
5. SCOTT THOMAS (USA)
7. AZHIKANOV NURKANAT (KAZ)
7. SAM HAMZA (MAR)

*Seeded

Referees:			

Male Kumite -75 Kg - Round Robin (each against each)

Karate World Championships - Individual World Championships - Cairo 2025, 3894+XV8, Al Estad, Qesm Than Madinet Nasr, Cairo Governorate 4436020, EGY

Tatami

Pool

5/8

1	(*8) DURHAM M. (AUS)	#205 / 27.11	7	(*8) DURHAM M. (AUS)
2	(*21) SAM H. (MAR)		5	
3	(*16) AL NAJJAR S. (JOR)	#206 / 27.11	0	(*11) ZYGOURIS K. (GRE)
4	(*11) ZYGOURIS K. (GRE)		4	
5	(*21) SAM H. (MAR)		6	(*21) SAM H. (MAR)
6	(*16) AL NAJJAR S. (JOR)		5	
7	(*8) DURHAM M. (AUS)	#210 / 27.11	4	(*11) ZYGOURIS K. (GRE)
8	(*11) ZYGOURIS K. (GRE)		7	
9	(*8) DURHAM M. (AUS)	#213 / 27.11	4	(*16) AL NAJJAR S. (JOR)
10	(*16) AL NAJJAR S. (JOR)		4	
11	(*21) SAM H. (MAR)	#214 / 27.11	3	(*21) SAM H. (MAR)
12	(*11) ZYGOURIS K. (GRE)		2	

1. SAM HAMZA (MAR)
2. ZYGOURIS KONSTANTINOS (GRE)
3. AL NAJJAR SAEED (JOR)
4. DURHAM MITCHELL (AUS)

1. ABDELAZIZ ABDALLA MAMDUH (EGY)
2. ZAPLITNYI ANDRII (UKR)
3. HARUTYUNYAN SUREN (ARM)
3. SHARAFUTDINOV ERNEST (WKF-1)
5. BERTHON ENZO (FRA)
5. SCOTT THOMAS (USA)
7. AZHIKANOV NURKANAT (KAZ)
7. SAM HAMZA (MAR)

*Seeded

Referees:			

















Male Kumite -75 Kg - Round Robin (each against each)

Karate World Championships - Individual World Championships - Cairo 2025, 3894+XV8, Al Estad, Qesm Than Madinet Nasr, Cairo Governorate 4436020, EGY

Tatami

Pool

6/8

1	 (*10) RODRIGUEZ FUENTES M. (CHI)	
	#207 / 27.11	1  (*25) ALZAHRANI S. (KSA)
2	 (*25) ALZAHRANI S. (KSA)	
	PTS	3
3	 (*12) HARSPATAKI K. (HUN)	
	#208 / 27.11	1  (*12) HARSPATAKI K. (HUN)
4	 (*4) YURUR O. (TUR)	
	PTS	0
5	 (*25) ALZAHRANI S. (KSA)	
	#211 / 27.11	3  (*25) ALZAHRANI S. (KSA)
6	 (*12) HARSPATAKI K. (HUN)	
	PTS	0
7	 (*10) RODRIGUEZ FUENTES M. (CHI)	
	#212 / 27.11	0  (*4) YURUR O. (TUR)
8	 (*4) YURUR O. (TUR)	
	PTS	4
9	 (*10) RODRIGUEZ FUENTES M. (CHI)	
	#215 / 27.11	3  (*12) HARSPATAKI K. (HUN)
10	 (*12) HARSPATAKI K. (HUN)	
	PTS	4
11	 (*25) ALZAHRANI S. (KSA)	
	#216 / 27.11	1  (*4) YURUR O. (TUR)
12	 (*4) YURUR O. (TUR)	
	PTS	3

1. YURUR OMER FARUK (TUR)
2. ALZAHRANI SULTAN (KSA)
3. HARSPATAKI KAROLY GABOR (HUN)
4. RODRIGUEZ FUENTES MATIAS (CHI)

1. ABDELAZIZ ABDALLA MAMDUH (EGY)
2. ZAPLITNYI ANDRII (UKR)
3. HARUTYUNYAN SUREN (ARM)
3. SHARAFUTDINOV ERNEST (WKF-1)
5. BERTHON ENZO (FRA)
5. SCOTT THOMAS (USA)
7. AZHIKANOV NURKANAT (KAZ)
7. SAM HAMZA (MAR)

*Seeded

Referees:			

Male Kumite -75 Kg - Round Robin (each against each)

Karate World Championships - Individual World Championships - Cairo 2025, 3894+XV8, Al Estad, Qesm Than Madinet Nasr, Cairo Governorate 4436020, EGY

Tatami

Pool

7/8

1	(*15) SAKIYAMA Y. (JPN)		
	#268 / 27.11	3	(*15) SAKIYAMA Y. (JPN)
2	(*22) FRANKEN R. (NED)		
	PTS	1	
3	(*28) SCOTT T. (USA)		
	#269 / 27.11	1	(*28) SCOTT T. (USA)
4	(*18) ABUDABOUS M. (LBA)		
	PTS	0	
5	(*22) FRANKEN R. (NED)		
	#271 / 27.11	4	(*22) FRANKEN R. (NED)
6	(*28) SCOTT T. (USA)		
	PTS	1	
7	(*15) SAKIYAMA Y. (JPN)		
	#272 / 27.11	4	(*15) SAKIYAMA Y. (JPN)
8	(*18) ABUDABOUS M. (LBA)		
	PTS	3	
9	(*15) SAKIYAMA Y. (JPN)		
	#274 / 27.11	2	(*28) SCOTT T. (USA)
10	(*28) SCOTT T. (USA)		
	PTS	3	
11	(*22) FRANKEN R. (NED)		
	#275 / 27.11	0	(*18) ABUDABOUS M. (LBA)
12	(*18) ABUDABOUS M. (LBA)		
	PTS	2	

1. SCOTT THOMAS (USA)
2. SAKIYAMA YUSEI (JPN)
3. ABUDABOUS MOHAMED (LBA)
4. FRANKEN RICARDO (NED)

1. ABDELAZIZ ABDALLA MAMDUH (EGY)
2. ZAPLITNYI ANDRII (UKR)
3. HARUTYUNYAN SUREN (ARM)
3. SHARAFUTDINOV ERNEST (WKF-1)
5. BERTHON ENZO (FRA)
5. SCOTT THOMAS (USA)
7. AZHIKANOV NURKANAT (KAZ)
7. SAM HAMZA (MAR)

*Seeded

Referees:			







Male Kumite -75 Kg - Round Robin (each against each)

Karate World Championships - Individual World Championships - Cairo 2025, 3894+XV8, Al Estad, Qesm Than Madinet Nasr, Cairo Governorate 4436020, EGY

Tatami

Pool

8/8

1	 (*20) MIKULIC N. (MNE)	0
	#270 / 27.11	
2	 (*14) DE VIVO D. (ITA)	0
3	 (*20) MIKULIC N. (MNE)	3
	#276 / 27.11	 (*1) ABDELAZIZ A. (EGY)
4	 (*1) ABDELAZIZ A. (EGY)	9
5	 (*14) DE VIVO D. (ITA)	1
	#273 / 27.11	
6	 (*1) ABDELAZIZ A. (EGY)	1

1. ABDELAZIZ ABDALLA MAMDUH (EGY)
2. DE VIVO DANIELE (ITA)
3. MIKULIC NEMANJA (MNE)

1. ABDELAZIZ ABDALLA MAMDUH (EGY)
2. ZAPLITNYI ANDRII (UKR)
3. HARUTYUNYAN SUREN (ARM)
3. SHARAFUTDINOV ERNEST (WKF-1)
5. BERTHON ENZO (FRA)
5. SCOTT THOMAS (USA)
7. AZHIKANOV NURKANAT (KAZ)
7. SAM HAMZA (MAR)

*Seeded

Referees:			

Male Kumite -75 Kg

Karate World Championships - Individual World Championships - Cairo 2025

Tatami

Pool

1,2,3,4,5,6,7,8

(c)sportdata GmbH & Co KG 2000-2025 (2025-12-02 21:54) v 11.0.0 build 2 (2025-11-22 17:48 CET) License: SDIL TVG ODF (expire 2026-01-23)

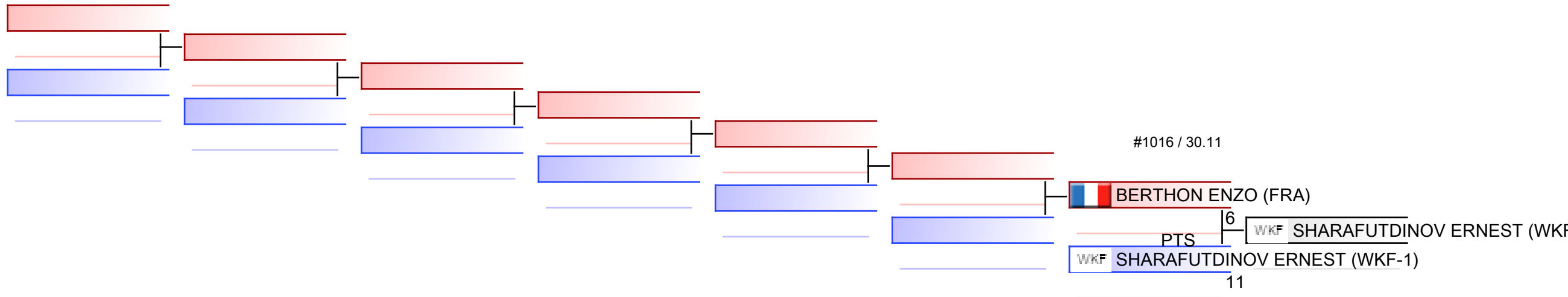

REPECHAGE: (1,2,3,4,5,6,7,8)

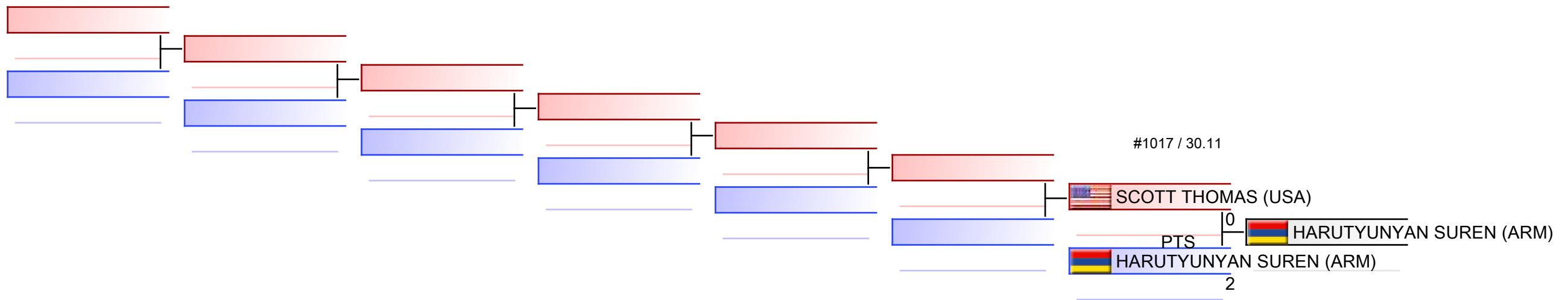

Referees:							
-----------	--	--	--	--	--	--	--



Karate World Championships - Individual World Championships - Cairo 2025 - 2025-11-27



Official Results

Male Kumite -75 Kg			
1	ABDELAZIZ ABDALLA MAMDUH		EGY - EGYPT
2	ZAPLITNYI ANDRII		UKR - UKRAINE
3	HARUTYUNYAN SUREN		ARM - ARMENIA
3	SHARAFUTDINOV ERNEST		WKF-1 - WKF-1
5	BERTHON ENZO		FRA - FRANCE
5	SCOTT THOMAS		USA - UNITED STATES
7	AZHIKANOV NURKANAT		KAZ - KAZAKHSTAN
7	SAM HAMZA		MAR - MOROCCO

MALE KUMITE -84 KG



Karate World Championships - Individual World Cha ..



ENTRIES BY WEIGHT CATEGORY

Male Kumite -84 Kg

As of 2 DEC 2025

Code	ID	Gender	Name	Seeding
ALB	ALB02650	M	MELOS GASHI	5
ALG	ALG04850	M	MIDOUNE FALLEH	6
ANG	ANG002067	M	MAYALA LEONARDO	7
ARM	ARM2223	M	NERSISYAN GOR	8
AUS	AUS2089	M	FREUND JONATHAN	9
AZE	AZE211	M	HASANOV TURGUT	10
BRA	BRA2716	M	ALBERTO FILIPE	11
CHI	CHI2116	M	HUAIQUIMAN FABIAN	12
COL	COL168	M	HENAO AMU RUBEN DARIO	14
CRO	CRO399	M	KVESIC IVAN	15
ECU	ECU02313	M	ACEVEDO JOSE ANTONIO	16
EGY	EGY2625	M	BADAWY YOUSSEF	2
ENG	ENG02926	M	PATRICK ASHTON	17
FRA	FRA2668	M	CONFIAC HENDRICK	18
GRE	GRE487	M	MASTROGIANNIS KONSTANTINOS	4
GUA	GUA115	M	RAMIREZ GONZALEZ BRANDON LIZANDRO	19
IND	IND2746	M	MAHARA BOOSHANAM AKSHAY	20
IRI	IRI2164	M	KHODABAKHSHI MAHDI	21
ITA	ITA494	M	MARTINA MICHELE	22
JOR	JOR2281	M	ALJAFARI MOHAMMAD	1
JPN	JPN2314	M	SHIMADA RIKITO	23
MAR	MAR2275	M	SRITI MEHDI	24
NED	NED2028	M	TIMMERMANS BRIAN	25
SEN	SEN02471	M	DIOP MAKHTAR	26
SRB	SRB2045	M	BREZANCIC VLADIMIR	27
SVK	SVK02501	M	SECKAR SIMON	28
TPE	TPE2232	M	PAN CHE-EN	13
TUN	TUN02634	M	GHAZOUANI RAYEN	29
TUR	TUR2211	M	ARSLAN HASAN	30
UKR	UKR274	M	CHOBOTAR VALERII	31
UZB	UZB02461	M	NAMOZOV SHUXRATJON	32
WKF-1	RUS03178	M	GASPARIAN EDUARD	3



















Male Kumite -84 Kg - Round Robin (each against each)

Karate World Championships - Individual World Championships - Cairo 2025, 3894+XV8, Al Estad, Qesm Than Madinet Nasr, Cairo Governorate 4436020, EGY

Tatami

Pool

1/8

1	 (*18) CONFIAC H. (FRA)	
	#301 / 28.11	2  (*23) SHIMADA R. (JPN)
2	 (*23) SHIMADA R. (JPN)	2
3	 (*11) ALBERTO F. (BRA)	
	#302 / 28.11	1  (*10) HASANOV T. (AZE)
4	 (*10) HASANOV T. (AZE)	2
	PTS	
5	 (*23) SHIMADA R. (JPN)	
	#305 / 28.11	1  (*23) SHIMADA R. (JPN)
6	 (*11) ALBERTO F. (BRA)	0
	PTS	
7	 (*18) CONFIAC H. (FRA)	
	#306 / 28.11	5  (*18) CONFIAC H. (FRA)
8	 (*10) HASANOV T. (AZE)	3
	PTS	
9	 (*18) CONFIAC H. (FRA)	
	#309 / 28.11	2  (*18) CONFIAC H. (FRA)
10	 (*11) ALBERTO F. (BRA)	0
	PTS	
11	 (*23) SHIMADA R. (JPN)	
	#310 / 28.11	9  (*23) SHIMADA R. (JPN)
12	 (*10) HASANOV T. (AZE)	8

1. SHIMADA RIKITO (JPN)
2. CONFIAC HENDRICK (FRA)
3. HASANOV TURGUT (AZE)
4. ALBERTO FILIPE (BRA)

1. BADAWY YOUSSEF (EGY)
2. ARSLAN HASAN (TUR)
3. ALJAFARI MOHAMMAD (JOR)
3. KVESIC IVAN (CRO)
5. GHAZOUANI RAYEN (TUN)
5. MARTINA MICHELE (ITA)
7. GASPARIAN EDUARD (WKF-1)
7. SRITI MEHDI (MAR)

*Seeded

Referees:			

Male Kumite -84 Kg - Round Robin (each against each)

Karate World Championships - Individual World Championships - Cairo 2025, 3894+XV8, Al Estad, Qesm Than Madinet Nasr, Cairo Governorate 4436020, EGY

Tatami

Pool
2/8

1	(*28) SECKAR S. (SVK)	
	#303 / 28.11	7 (*28) SECKAR S. (SVK)
2	(*7) MAYALA L. (ANG)	6
3	(*13) PAN C. (TPE)	
	#304 / 28.11	2 WKF (*3) GASPARIAN E. (WKF-1)
4	WKF (*3) GASPARIAN E. (WKF-1)	4
	PTS	
5	(*7) MAYALA L. (ANG)	
	#307 / 28.11	3 (*7) MAYALA L. (ANG)
6	(*13) PAN C. (TPE)	1
7	(*28) SECKAR S. (SVK)	
	#308 / 28.11	2 WKF (*3) GASPARIAN E. (WKF-1)
8	WKF (*3) GASPARIAN E. (WKF-1)	4
	SEN	
9	(*28) SECKAR S. (SVK)	
	#311 / 28.11	5 (*28) SECKAR S. (SVK)
10	(*13) PAN C. (TPE)	5
11	(*7) MAYALA L. (ANG)	
	#312 / 28.11	1 WKF (*3) GASPARIAN E. (WKF-1)
12	WKF (*3) GASPARIAN E. (WKF-1)	2

1. GASPARIAN EDUARD (WKF-1)
2. SECKAR SIMON (SVK)
3. MAYALA LEONARDO (ANG)
4. PAN CHE-EN (TPE)

1. BADAWY YOUSSEF (EGY)
2. ARSLAN HASAN (TUR)
3. ALJAFARI MOHAMMAD (JOR)
3. KVESIC IVAN (CRO)
5. GHAZOUANI RAYEN (TUN)
5. MARTINA MICHELE (ITA)
7. GASPARIAN EDUARD (WKF-1)
7. SRITI MEHDI (MAR)

*Seeded

Referees:			

Male Kumite -84 Kg - Round Robin (each against each)

Karate World Championships - Individual World Championships - Cairo 2025, 3894+XV8, Al Estad, Qesm Than Madinet Nasr, Cairo Governorate 4436020, EGY

Tatami

Pool
3/8

1	(*32) NAMOZOV S. (UZB)	#373 / 28.11	4	(*32) NAMOZOV S. (UZB)
2	(*9) FREUND J. (AUS)		0	
3	(*14) HENAO AMU R. (COL)	#374 / 28.11	0	(*25) TIMMERMANS B. (NED)
4	(*25) TIMMERMANS B. (NED)		1	
5	(*9) FREUND J. (AUS)	#377 / 28.11	1	(*14) HENAO AMU R. (COL)
6	(*14) HENAO AMU R. (COL)		4	
7	(*32) NAMOZOV S. (UZB)	PTS	1	(*32) NAMOZOV S. (UZB)
8	(*25) TIMMERMANS B. (NED)	#378 / 28.11	0	
9	(*32) NAMOZOV S. (UZB)	#381 / 28.11	1	(*14) HENAO AMU R. (COL)
10	(*14) HENAO AMU R. (COL)		2	
11	(*9) FREUND J. (AUS)	#382 / 28.11	0	(*25) TIMMERMANS B. (NED)
12	(*25) TIMMERMANS B. (NED)		3	

1. HENAO AMU RUBEN DARIO (COL)
2. NAMOZOV SHUXRATJON (UZB)
3. TIMMERMANS BRIAN (NED)
4. FREUND JONATHAN (AUS)

1. BADAWY YOUSSEF (EGY)
2. ARSLAN HASAN (TUR)
3. ALJAFARI MOHAMMAD (JOR)
3. KVESIC IVAN (CRO)
5. GHAZOUANI RAYEN (TUN)
5. MARTINA MICHELE (ITA)
7. GASPARIAN EDUARD (WKF-1)
7. SRITI MEHDI (MAR)

*Seeded

Referees:			

Male Kumite -84 Kg - Round Robin (each against each)

Karate World Championships - Individual World Championships - Cairo 2025, 3894+XV8, Al Estad, Qesm Than Madinet Nasr, Cairo Governorate 4436020, EGY

Tatami

Pool
4/8

1	(*12) HUAIQUIMAN F. (CHI)	#375 / 28.11	0
2	(*22) MARTINA M. (ITA)		0
3	(*5) MELOS G. (ALB)	#376 / 28.11	0
4	(*2) BADAWEY Y. (EGY)		3
5	(*22) MARTINA M. (ITA)	#379 / 28.11	5
6	(*5) MELOS G. (ALB)		0
7	(*12) HUAIQUIMAN F. (CHI)	#380 / 28.11	2
8	(*2) BADAWEY Y. (EGY)		5
9	(*12) HUAIQUIMAN F. (CHI)	#383 / 28.11	0
10	(*5) MELOS G. (ALB)		4
11	(*22) MARTINA M. (ITA)	#384 / 28.11	1
12	(*2) BADAWEY Y. (EGY)		2

1. BADAWEY YOUSSEF (EGY)
2. MARTINA MICHELE (ITA)
3. MELOS GASHI (ALB)
4. HUAIQUIMAN FABIAN (CHI)

1. BADAWEY YOUSSEF (EGY)
2. ARSLAN HASAN (TUR)
3. ALJAFARI MOHAMMAD (JOR)
3. KVESIC IVAN (CRO)
5. GHAZOUANI RAYEN (TUN)
5. MARTINA MICHELE (ITA)
7. GASPARIAN EDUARD (WKF-1)
7. SRITI MEHDI (MAR)

*Seeded

Referees:			

Male Kumite -84 Kg - Round Robin (each against each)

Karate World Championships - Individual World Championships - Cairo 2025, 3894+XV8, Al Estad, Qesm Than Madinet Nasr, Cairo Governorate 4436020, EGY

Tatami

Pool
5/8

1	(*6) MIDOUNE F. (ALG)	#442 / 28.11	2	(*6) MIDOUNE F. (ALG)
2	(*21) KHODABAKHSHI M. (IRI)		2	
3	(*16) ACEVEDO J. (ECU)	#443 / 28.11	6	(*27) BREZANCIC V. (SRB)
4	(*27) BREZANCIC V. (SRB)		9	
5	(*21) KHODABAKHSHI M. (IRI)	#446 / 28.11	9	(*21) KHODABAKHSHI M. (IRI)
6	(*16) ACEVEDO J. (ECU)		0	
7	(*6) MIDOUNE F. (ALG)	#447 / 28.11	5	(*6) MIDOUNE F. (ALG)
8	(*27) BREZANCIC V. (SRB)		4	
9	(*6) MIDOUNE F. (ALG)	#450 / 28.11	2	(*6) MIDOUNE F. (ALG)
10	(*16) ACEVEDO J. (ECU)		1	
11	(*21) KHODABAKHSHI M. (IRI)	#451 / 28.11	0	(*27) BREZANCIC V. (SRB)
12	(*27) BREZANCIC V. (SRB)		6	

1. MIDOUNE FALLEH (ALG)
2. BREZANCIC VLADIMIR (SRB)
3. KHODABAKHSHI MAHDI (IRI)
4. ACEVEDO JOSE ANTONIO (ECU)

1. BADAWY YOUSSEF (EGY)
2. ARSLAN HASAN (TUR)
3. ALJAFARI MOHAMMAD (JOR)
3. KVESIC IVAN (CRO)
5. GHAZOUANI RAYEN (TUN)
5. MARTINA MICHELE (ITA)
7. GASPARIAN EDUARD (WKF-1)
7. SRITI MEHDI (MAR)

*Seeded

Referees:			

Male Kumite -84 Kg - Round Robin (each against each)

Karate World Championships - Individual World Championships - Cairo 2025, 3894+XV8, Al Estad, Qesm Than Madinet Nasr, Cairo Governorate 4436020, EGY

Tatami

Pool
6/8

1	(*20) MAHARA BOOSHANAM A. (IND)	#444 / 28.11	0	(*29) GHAZOUANI R. (TUN)
2	(*29) GHAZOUANI R. (TUN)		4	
		PTS		
3	(*30) ARSLAN H. (TUR)	#445 / 28.11	5	(*30) ARSLAN H. (TUR)
4	(*4) MASTROGIANNIS K. (GRE)		0	
5	(*29) GHAZOUANI R. (TUN)	#448 / 28.11	0	(*30) ARSLAN H. (TUR)
6	(*30) ARSLAN H. (TUR)		4	
7	(*20) MAHARA BOOSHANAM A. (IND)	#449 / 28.11	0	(*4) MASTROGIANNIS K. (GRE)
8	(*4) MASTROGIANNIS K. (GRE)		3	
9	(*20) MAHARA BOOSHANAM A. (IND)	#452 / 28.11	0	(*30) ARSLAN H. (TUR)
10	(*30) ARSLAN H. (TUR)		1	
		PTS		
11	(*29) GHAZOUANI R. (TUN)	#453 / 28.11	5	(*29) GHAZOUANI R. (TUN)
12	(*4) MASTROGIANNIS K. (GRE)		1	

1. ARSLAN HASAN (TUR)
2. GHAZOUANI RAYEN (TUN)
3. MASTROGIANNIS KONSTANTINOS (GRE)
4. MAHARA BOOSHANAM AKSHAY (IND)

1. BADAUWY YOUSSEF (EGY)
2. ARSLAN HASAN (TUR)
3. ALJAFARI MOHAMMAD (JOR)
3. KVESIC IVAN (CRO)
5. GHAZOUANI RAYEN (TUN)
5. MARTINA MICHELE (ITA)
7. GASPARIAN EDUARD (WKF-1)
7. SRITI MEHDI (MAR)

*Seeded

Referees:			



















Male Kumite -84 Kg - Round Robin (each against each)

Karate World Championships - Individual World Championships - Cairo 2025, 3894+XV8, Al Estad, Qesm Than Madinet Nasr, Cairo Governorate 4436020, EGY

Tatami

Pool

7/8

1	 (*8) NERSISYAN G. (ARM)	
	#511 / 28.11	1  (*24) SRITI M. (MAR)
2	 (*24) SRITI M. (MAR)	
		8
3	 (*19) RAMIREZ GONZALEZ B. (GUA)	
	#512 / 28.11	1  (*31) CHOBOTAR V. (UKR)
4	 (*31) CHOBOTAR V. (UKR)	
		6
		PTS
5	 (*24) SRITI M. (MAR)	
	#515 / 28.11	6  (*24) SRITI M. (MAR)
6	 (*19) RAMIREZ GONZALEZ B. (GUA)	
		1
7	 (*8) NERSISYAN G. (ARM)	
	#516 / 28.11	2  (*31) CHOBOTAR V. (UKR)
8	 (*31) CHOBOTAR V. (UKR)	
		3
9	 (*8) NERSISYAN G. (ARM)	
	#519 / 28.11	6  (*19) RAMIREZ GONZALEZ B. (GUA)
10	 (*19) RAMIREZ GONZALEZ B. (GUA)	
		10
		PTS
11	 (*24) SRITI M. (MAR)	
	#520 / 28.11	3  (*24) SRITI M. (MAR)
12	 (*31) CHOBOTAR V. (UKR)	
		2

1. SRITI MEHDI (MAR)
2. CHOBOTAR VALERII (UKR)
3. RAMIREZ GONZALEZ BRANDON LIZANDRO (GUA)
4. NERSISYAN GOR (ARM)

1. BADAWY YOUSSEF (EGY)
2. ARSLAN HASAN (TUR)
3. ALJAFARI MOHAMMAD (JOR)
3. KVESIC IVAN (CRO)
5. GHAZOUANI RAYEN (TUN)
5. MARTINA MICHELE (ITA)
7. GASPARIAN EDUARD (WKF-1)
7. SRITI MEHDI (MAR)

*Seeded

Referees:			

Male Kumite -84 Kg - Round Robin (each against each)

Karate World Championships - Individual World Championships - Cairo 2025, 3894+XV8, Al Estad, Qesm Than Madinet Nasr, Cairo Governorate 4436020, EGY

Tatami

Pool
8/8

1	(*15) KVESIC I. (CRO)	
	#513 / 28.11	3 (*15) KVESIC I. (CRO)
2	(*17) PATRICK A. (ENG)	1
3	(*26) DIOP M. (SEN)	
	#514 / 28.11	0 (*1) ALJAFARI M. (JOR)
4	(*1) ALJAFARI M. (JOR)	8
5	(*17) PATRICK A. (ENG)	
	#517 / 28.11	0
6	(*26) DIOP M. (SEN)	0
	PTS	
7	(*15) KVESIC I. (CRO)	
	#518 / 28.11	3 (*15) KVESIC I. (CRO)
8	(*1) ALJAFARI M. (JOR)	3
	PTS	
9	(*15) KVESIC I. (CRO)	
	#521 / 28.11	2 (*15) KVESIC I. (CRO)
10	(*26) DIOP M. (SEN)	0
11	(*17) PATRICK A. (ENG)	
	#522 / 28.11	3 (*1) ALJAFARI M. (JOR)
12	(*1) ALJAFARI M. (JOR)	7

1. KVESIC IVAN (CRO)
2. ALJAFARI MOHAMMAD (JOR)
3. PATRICK ASHTON (ENG)
4. DIOP MAKHTAR (SEN)

1. BADAWY YOUSSEF (EGY)
2. ARSLAN HASAN (TUR)
3. ALJAFARI MOHAMMAD (JOR)
3. KVESIC IVAN (CRO)
5. GHAZOUANI RAYEN (TUN)
5. MARTINA MICHELE (ITA)
7. GASPARIAN EDUARD (WKF-1)
7. SRITI MEHDI (MAR)

*Seeded

Referees:			

Pool winner-Male Kumite -84 Kg

Karate World Championships - Individual World Championships - Cairo 2025, 3894+XV8, Al Estad, Qesm Than Madinet Nasr, Cairo Governorate 4436020, EGY

Tatami

Pool

1/1

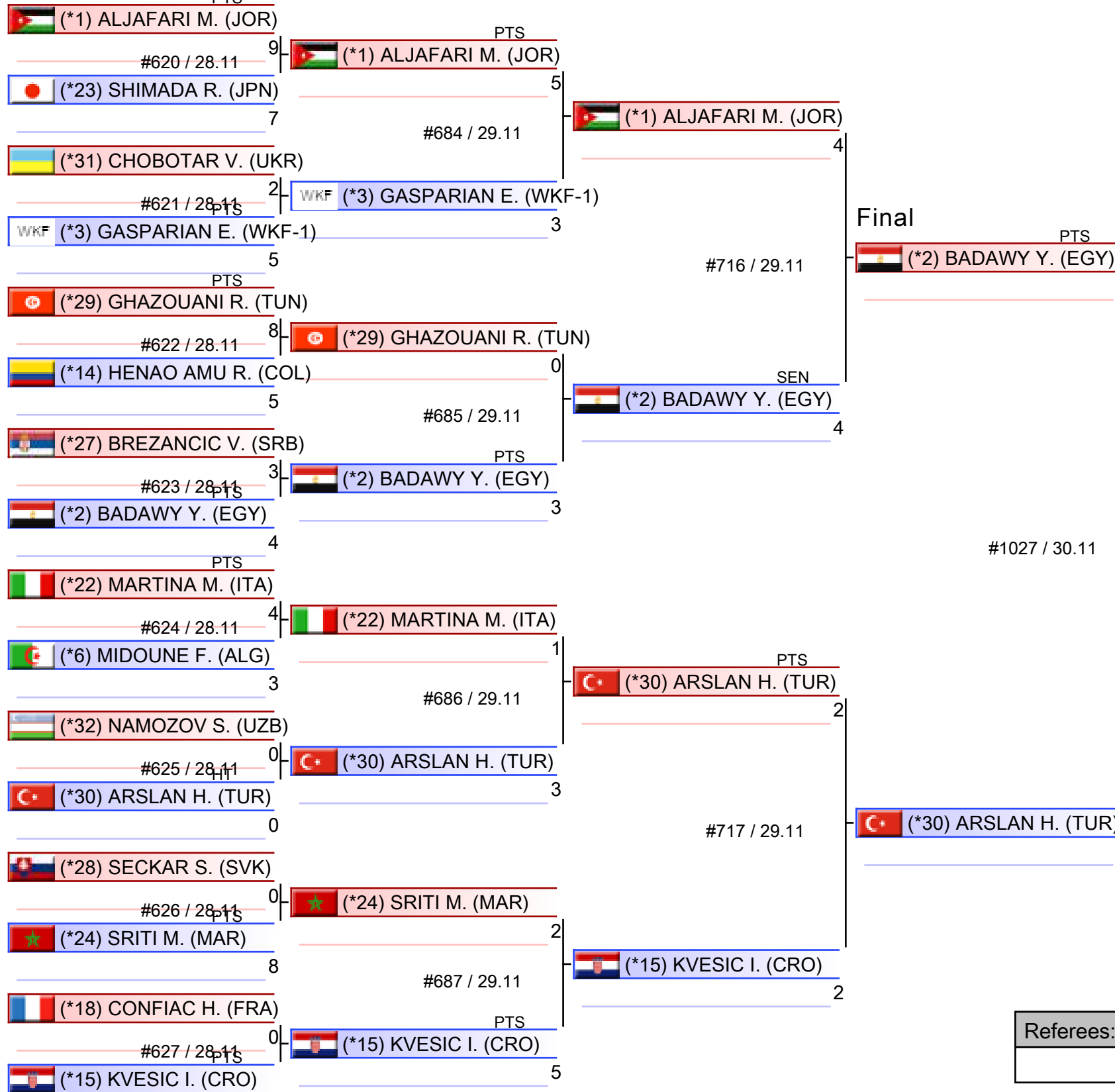

1. BADAWY YOUSSEF (EGY)
2. ARSLAN HASAN (TUR)
3. ALJAFARI MOHAMMAD (JOR)
3. KVESIC IVAN (CRO)
5. GHAZOUANI RAYEN (TUN)
5. MARTINA MICHELE (ITA)
7. GASPARIAN EDUARD (WKF-1)
7. SRITI MEHDI (MAR)

*Seeded

Referees:			

Male Kumite -84 Kg

Karate World Championships - Individual World Championships - Cairo 2025

(c)sportdata GmbH & Co KG 2000-2025 (2025-12-02 21:54) v 11.0.0 build 2 (2025-11-22 17:48 CET) License: SDIL TVG ODF (expire 2026-01-23)

Tatami

Pool
1,2,3,4,5,6,7,8

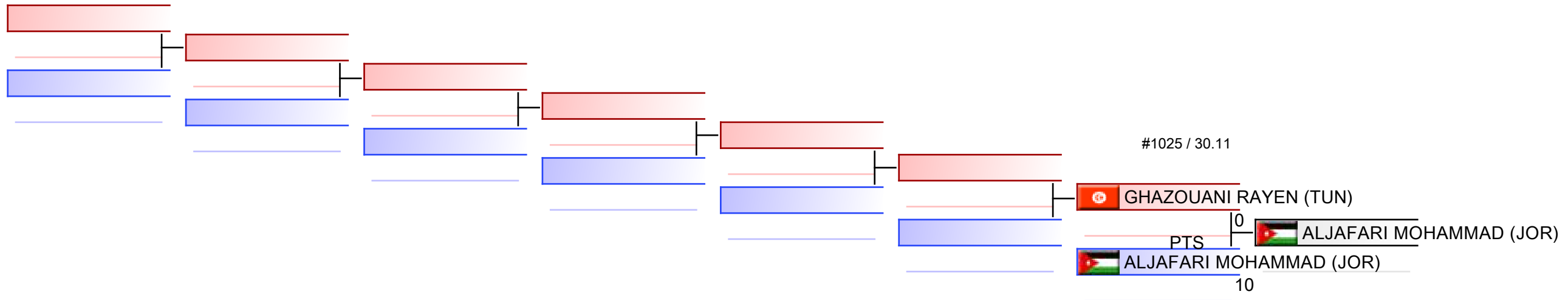

REPECHAGE: (1,2,3,4,5,6,7,8)

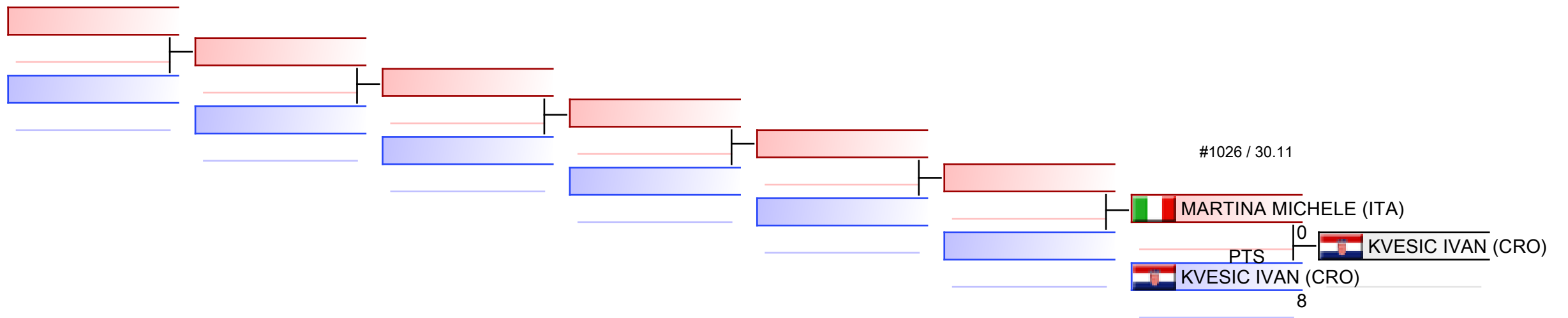

Referees:							
-----------	--	--	--	--	--	--	--



Karate World Championships - Individual World
Championships - Cairo 2025 - 2025-11-27



Official Results

Male Kumite -84 Kg			
1	BADAWY YOUSSEF		EGY - EGYPT
2	ARSLAN HASAN		TUR - TURKIYE
3	ALJAFARI MOHAMMAD		JOR - JORDAN
3	KVESIC IVAN		CRO - CROATIA
5	GHAZOUANI RAYEN		TUN - TUNISIA
5	MARTINA MICHELE		ITA - ITALY
7	GASPARIAN EDUARD		WKF-1 - WKF-1
7	SRITI MEHDI		MAR - MOROCCO

MALE KUMITE 84+ KG



Karate World Championships - Individual World Cha ..



ENTRIES BY WEIGHT CATEGORY

Male Kumite 84+ Kg

As of 2 DEC 2025

Code	ID	Gender	Name	Seeding
ALG	ALG2163	M	DAIKHI HOCINE	5
ARU	ARU002084	M	TIMMERMANS ROB	6
AUS	AUS257	M	GEORGIEFF ANGEL	7
AZE	AZE201	M	GURBANLI ASIMAN	8
BIH	BIH2179	M	BOSTANDZIC ANES	4
BRA	BRA2069	M	FELIPIN SALGADO GIOVANI	9
CHI	CHI139	M	ROJAS RODRIGO	10
CRO	CRO367	M	KVESIC ANDJELO	3
CZE	CZE2153	M	BOSAK ONDREJ	11
DOM	DOM131	M	CASTILLO ANEL	12
ECU	ECU02356	M	VALLEJO CESAR ANTONIO	13
EGY	EGY2205	M	MAHMOUD TAHA TAREK	1
ESP	ESP02607	M	GUTIERREZ MARQUES BORJA	28
FRA	FRA2077	M	FILALI MEHDI	14
GEO	GEO02419	M	GELASHVILI MERABI	15
GRE	GRE774	M	NIKOPOULOS ATHANASIOS	16
IND	IND2207	M	SEHRAWAT SUDHIR	17
IRI	IRI2024	M	ABAZARI SALEH	18
ITA	ITA02948	M	AVANZINI MATTEO	2
JPN	JPN02706	M	YOSHIMURA FUMIYA	19
KAZ	KAZ02741	M	ULBEK DIAS	20
KSA	KSA2265	M	SUFYANI SANAD	24
LBA	LBA02105	M	ABDULSALAM NURI	21
LUX	LUX02279	M	DAVIES ALEXANDER	22
MAR	MAR2258	M	HANNI REDA	23
RSA	RSA003638	M	DHLAMINI BRESHNEV	27
SEN	SEN02432	M	DIOP MOUHAMADOU FALILOU	25
SRB	SRB526	M	TESANOVIC DJORDE	26
UKR	UKR2020	M	TALIBOV RYZVAN	29
USA	USA03000	M	SAGILYAN EDUARD	30
WKF-1	RUS03179	M	GOLOVIN MAKAR	31
WKF-2	AIN-2002778	M	KUDZINAU IVAN	32



















Male Kumite 84+ Kg - Round Robin (each against each)

Karate World Championships - Individual World Championships - Cairo 2025, 3894+XV8, Al Estad, Qesm Than Madinet Nasr, Cairo Governorate 4436020, EGY

Tatami

Pool

1/8

1	 (*15) GELASHVILI M. (GEO)	
	#325 / 28.11	5  (*15) GELASHVILI M. (GEO)
2	 (*12) CASTILLO A. (DOM)	
	PTS	2
3	 (*24) SUFYANI S. (KSA)	
	#326 / 28.11	8  (*24) SUFYANI S. (KSA)
4	 (*5) DAIKHI H. (ALG)	
	HA	3
5	 (*12) CASTILLO A. (DOM)	
	#329 / 28.11	4  (*12) CASTILLO A. (DOM)
6	 (*24) SUFYANI S. (KSA)	
		0
7	 (*15) GELASHVILI M. (GEO)	
	#330 / 28.11	1  (*5) DAIKHI H. (ALG)
8	 (*5) DAIKHI H. (ALG)	
		1
9	 (*15) GELASHVILI M. (GEO)	
	#333 / 28.11	1  (*24) SUFYANI S. (KSA)
10	 (*24) SUFYANI S. (KSA)	
		3
11	 (*12) CASTILLO A. (DOM)	
	#334 / 28.11	0  (*5) DAIKHI H. (ALG)
12	 (*5) DAIKHI H. (ALG)	
		4

1. SUFYANI SANAD (KSA)
2. DAIKHI HOCINE (ALG)
3. GELASHVILI MERABI (GEO)
4. CASTILLO ANEL (DOM)

1. AVANZINI MATTEO (ITA)
2. ABAZARI SALEH (IRI)
3. SUFYANI SANAD (KSA)
3. KUDZINAU IVAN (WKF-2)
5. ROJAS RODRIGO (CHI)
5. GURBANLI ASIMAN (AZE)
7. BOSTANDZIC ANES (BIH)
7. SAGILYAN EDUARD (USA)

*Seeded

Referees:			

Male Kumite 84+ Kg - Round Robin (each against each)

Karate World Championships - Individual World Championships - Cairo 2025, 3894+XV8, Al Estad, Qesm Than Madinet Nasr, Cairo Governorate 4436020, EGY

Tatami

Pool
2/8

1	 (*16) NIKOPOULOS A. (GRE)	0	 (*18) ABAZARI S. (IRI)
	#327 / 28.11		
2	 (*18) ABAZARI S. (IRI)	3	
	PTS		
3	 (*21) ABDULSALAM N. (LBA)	1	 (*21) ABDULSALAM N. (LBA)
	#328 / 28.11		
4	 (*3) KVESIC A. (CRO)	0	
	PTS		
5	 (*18) ABAZARI S. (IRI)	4	 (*18) ABAZARI S. (IRI)
	#331 / 28.11		
6	 (*21) ABDULSALAM N. (LBA)	0	
7	 (*16) NIKOPOULOS A. (GRE)	0	 (*3) KVESIC A. (CRO)
	#332 / 28.11		
8	 (*3) KVESIC A. (CRO)	3	
9	 (*16) NIKOPOULOS A. (GRE)	1	 (*21) ABDULSALAM N. (LBA)
	#335 / 28.11		
10	 (*21) ABDULSALAM N. (LBA)	2	
11	 (*18) ABAZARI S. (IRI)	0	
	#336 / 28.11		
12	 (*3) KVESIC A. (CRO)	0	

1. ABAZARI SALEH (IRI)
2. ABDULSALAM NURI (LBA)
3. KVESIC ANDJELO (CRO)
4. NIKOPOULOS ATHANASIOS (GRE)

1. AVANZINI MATTEO (ITA)
2. ABAZARI SALEH (IRI)
3. SUFYANI SANAD (KSA)
3. KUDZINAU IVAN (WKF-2)
5. ROJAS RODRIGO (CHI)
5. GURBANLI ASIMAN (AZE)
7. BOSTANDZIC ANES (BIH)
7. SAGILYAN EDUARD (USA)

*Seeded

Referees:			

Male Kumite 84+ Kg - Round Robin (each against each)

Karate World Championships - Individual World Championships - Cairo 2025, 3894+XV8, Al Estad, Qesm Than Madinet Nasr, Cairo Governorate 4436020, EGY

Tatami

Pool

3/8

1	(*13) VALLEJO C. (ECU)	#394 / 28.11	0	(*26) TESANOVIC D. (SRB)
2	(*26) TESANOVIC D. (SRB)		5	
3	(*32) KUDZINAU I. (WKF-2)	#395 / 28.11	0	(*7) GEORGIEFF A. (AUS)
4	(*7) GEORGIEFF A. (AUS)		4	
5	(*26) TESANOVIC D. (SRB)	#398 / 28.11	0	(*32) KUDZINAU I. (WKF-2)
6	(*32) KUDZINAU I. (WKF-2)		1	
7	(*13) VALLEJO C. (ECU)	#399 / 28.11	4	(*7) GEORGIEFF A. (AUS)
8	(*7) GEORGIEFF A. (AUS)		8	
9	(*13) VALLEJO C. (ECU)	#402 / 28.11	1	(*32) KUDZINAU I. (WKF-2)
10	(*32) KUDZINAU I. (WKF-2)		11	
		PTS		
11	(*26) TESANOVIC D. (SRB)	#403 / 28.11	7	(*26) TESANOVIC D. (SRB)
12	(*7) GEORGIEFF A. (AUS)		1	

1. GEORGIEFF ANGEL (AUS)
2. KUDZINAU IVAN (WKF-2)
3. TESANOVIC DJORDE (SRB)
4. VALLEJO CESAR ANTONIO (ECU)

1. AVANZINI MATTEO (ITA)
2. ABAZARI SALEH (IRI)
3. SUFYANI SANAD (KSA)
3. KUDZINAU IVAN (WKF-2)
5. ROJAS RODRIGO (CHI)
5. GURBANLI ASIMAN (AZE)
7. BOSTANDZIC ANES (BIH)
7. SAGILYAN EDUARD (USA)

*Seeded

Referees:			

Male Kumite 84+ Kg - Round Robin (each against each)

Karate World Championships - Individual World Championships - Cairo 2025, 3894+XV8, Al Estad, Qesm Than Madinet Nasr, Cairo Governorate 4436020, EGY

Tatami

Pool

4/8

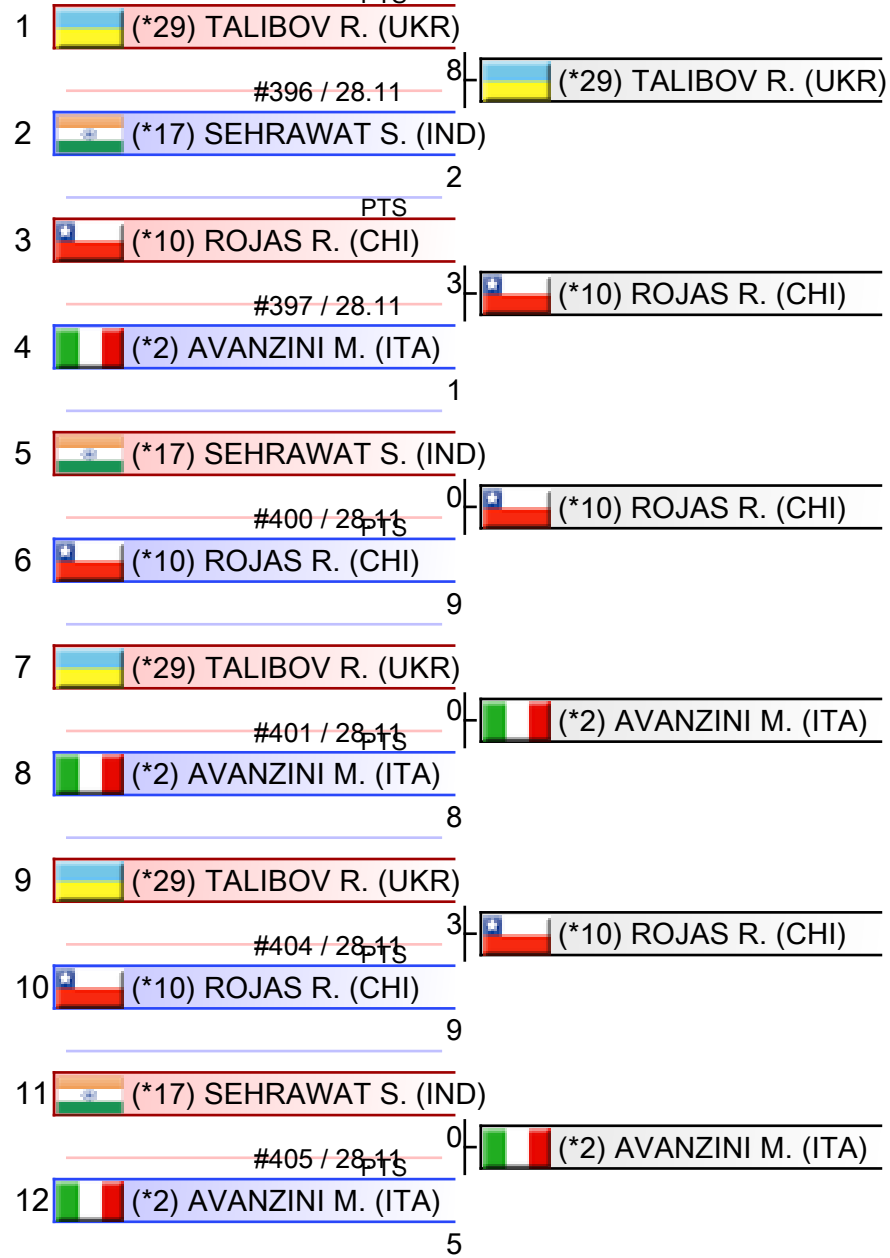

1. ROJAS RODRIGO (CHI)
2. AVANZINI MATTEO (ITA)
3. TALIBOV RYZVAN (UKR)
4. SEHRAWAT SUDHIR (IND)

1. AVANZINI MATTEO (ITA)
2. ABAZARI SALEH (IRI)
3. SUFYANI SANAD (KSA)
3. KUDZINAU IVAN (WKF-2)
5. ROJAS RODRIGO (CHI)
5. GURBANLI ASIMAN (AZE)
7. BOSTANDZIC ANES (BIH)
7. SAGILYAN EDUARD (USA)

*Seeded

Referees:			



















Male Kumite 84+ Kg - Round Robin (each against each)

Karate World Championships - Individual World Championships - Cairo 2025, 3894+XV8, Al Estad, Qesm Than Madinet Nasr, Cairo Governorate 4436020, EGY

Tatami

Pool

5/8

1	 (*25) DIOP M. (SEN)	10	 (*25) DIOP M. (SEN)
	#466 / 28.11		
2	 (*19) YOSHIMURA F. (JPN)	5	
3	 (*6) TIMMERMANS R. (ARU)	3	 (*14) FILALI M. (FRA)
	#467 / 28.11		
4	 (*14) FILALI M. (FRA)	6	
	PTS		
5	 (*19) YOSHIMURA F. (JPN)	5	 (*19) YOSHIMURA F. (JPN)
	#470 / 28.11		
6	 (*6) TIMMERMANS R. (ARU)	3	
7	 (*25) DIOP M. (SEN)	0	 (*14) FILALI M. (FRA)
	#471 / 28.11		
8	 (*14) FILALI M. (FRA)	5	
9	 (*25) DIOP M. (SEN)	5	 (*6) TIMMERMANS R. (ARU)
	#474 / 28.11		
10	 (*6) TIMMERMANS R. (ARU)	7	
11	 (*19) YOSHIMURA F. (JPN)	1	 (*14) FILALI M. (FRA)
	#475 / 28.11		
12	 (*14) FILALI M. (FRA)	7	

1. FILALI MEHDI (FRA)
2. DIOP MOUHAMADOU FALILOU (SEN)
3. YOSHIMURA FUMIYA (JPN)
4. TIMMERMANS ROB (ARU)

1. AVANZINI MATTEO (ITA)
2. ABAZARI SALEH (IRI)
3. SUFYANI SANAD (KSA)
3. KUDZINAU IVAN (WKF-2)
5. ROJAS RODRIGO (CHI)
5. GURBANLI ASIMAN (AZE)
7. BOSTANDZIC ANES (BIH)
7. SAGILYAN EDUARD (USA)

*Seeded

Referees:			

Male Kumite 84+ Kg - Round Robin (each against each)

Karate World Championships - Individual World Championships - Cairo 2025, 3894+XV8, Al Estad, Qesm Than Madinet Nasr, Cairo Governorate 4436020, EGY

Tatami

Pool
6/8

1	(*20) ULBEK D. (KAZ)	#468 / 28.11	2	(*31) GOLOVIN M. (WKF-1)
2	(*31) GOLOVIN M. (WKF-1)	#469 / 28.11	0	(*4) BOSTANDZIC A. (BIH)
3	(*27) DHLAMINI B. (RSA)	#472 / 28.11	8	(*31) GOLOVIN M. (WKF-1)
4	(*4) BOSTANDZIC A. (BIH)	#473 / 28.11	0	(*20) ULBEK D. (KAZ)
5	(*31) GOLOVIN M. (WKF-1)	#476 / 28.11	8	(*20) ULBEK D. (KAZ)
6	(*27) DHLAMINI B. (RSA)	#477 / 28.11	3	(*31) GOLOVIN M. (WKF-1)
7	(*20) ULBEK D. (KAZ)			
8	(*4) BOSTANDZIC A. (BIH)			
9	(*20) ULBEK D. (KAZ)			
10	(*27) DHLAMINI B. (RSA)			
11	(*31) GOLOVIN M. (WKF-1)			
12	(*4) BOSTANDZIC A. (BIH)			

1. GOLOVIN MAKAR (WKF-1)
2. BOSTANDZIC ANES (BIH)
3. ULBEK DIAS (KAZ)
4. DHLAMINI BRESHNEV (RSA)

1. AVANZINI MATTEO (ITA)
2. ABAZARI SALEH (IRI)
3. SUFYANI SANAD (KSA)
3. KUDZINAU IVAN (WKF-2)
5. ROJAS RODRIGO (CHI)
5. GURBANLI ASIMAN (AZE)
7. BOSTANDZIC ANES (BIH)
7. SAGILYAN EDUARD (USA)

*Seeded

Referees:			

Male Kumite 84+ Kg - Round Robin (each against each)

Karate World Championships - Individual World Championships - Cairo 2025, 3894+XV8, Al Estad, Qesm Than Madinet Nasr, Cairo Governorate 4436020, EGY

Tatami

Pool

7/8

1	 (*30) SAGILYAN E. (USA)	5	 (*30) SAGILYAN E. (USA)
	#532 / 28.11		
2	 (*11) BOSAK O. (CZE)	0	
	PTS		
3	 (*23) HANNI R. (MAR)	7	 (*23) HANNI R. (MAR)
	#533 / 28.11		
4	 (*22) DAVIES A. (LUX)	2	
	PTS		
5	 (*11) BOSAK O. (CZE)	4	 (*11) BOSAK O. (CZE)
	#536 / 28.11		
6	 (*23) HANNI R. (MAR)	2	
	PTS		
7	 (*30) SAGILYAN E. (USA)	4	 (*30) SAGILYAN E. (USA)
	#537 / 28.11		
8	 (*22) DAVIES A. (LUX)	3	
	PTS		
9	 (*30) SAGILYAN E. (USA)	7	 (*30) SAGILYAN E. (USA)
	#540 / 28.11		
10	 (*23) HANNI R. (MAR)	6	
	PTS		
11	 (*11) BOSAK O. (CZE)	4	 (*11) BOSAK O. (CZE)
	#541 / 28.11		
12	 (*22) DAVIES A. (LUX)	1	

1. SAGILYAN EDUARD (USA)
2. BOSAK ONDREJ (CZE)
3. HANNI REDA (MAR)
4. DAVIES ALEXANDER (LUX)

1. AVANZINI MATTEO (ITA)
2. ABAZARI SALEH (IRI)
3. SUFYANI SANAD (KSA)
3. KUDZINAU IVAN (WKF-2)
5. ROJAS RODRIGO (CHI)
5. GURBANLI ASIMAN (AZE)
7. BOSTANDZIC ANES (BIH)
7. SAGILYAN EDUARD (USA)

*Seeded

Referees:			

Male Kumite 84+ Kg - Round Robin (each against each)

Karate World Championships - Individual World Championships - Cairo 2025, 3894+XV8, Al Estad, Qesm Than Madinet Nasr, Cairo Governorate 4436020, EGY

Tatami

Pool

8/8

1	 (*9) FELIPIN SALGADO G. (BRA)	
	#534 / 28.11	4  (*9) FELIPIN SALGADO G. (BRA)
2	 (*28) GUTIERREZ MARQUES B. (ESP)	
	PTS	2
3	 (*8) GURBANLI A. (AZE)	
	#535 / 28.11	8  (*8) GURBANLI A. (AZE)
4	 (*1) MAHMOUD T. (EGY)	
		7
5	 (*28) GUTIERREZ MARQUES B. (ESP)	
	#538 / 28.11	0  (*8) GURBANLI A. (AZE)
6	 (*8) GURBANLI A. (AZE)	
		4
7	 (*9) FELIPIN SALGADO G. (BRA)	
	#539 / 28.11	0  (*1) MAHMOUD T. (EGY)
8	 (*1) MAHMOUD T. (EGY)	
		5
9	 (*9) FELIPIN SALGADO G. (BRA)	
	#542 / 28.11	3  (*8) GURBANLI A. (AZE)
10	 (*8) GURBANLI A. (AZE)	
		6
11	 (*28) GUTIERREZ MARQUES B. (ESP)	
	#543 / 28.11	0  (*1) MAHMOUD T. (EGY)
12	 (*1) MAHMOUD T. (EGY)	
		8

1. GURBANLI ASIMAN (AZE)
2. MAHMOUD TAHA TAREK (EGY)
3. FELIPIN SALGADO GIOVANI (BRA)
4. GUTIERREZ MARQUES BORJA (ESP)

1. AVANZINI MATTEO (ITA)
2. ABAZARI SALEH (IRI)
3. SUFYANI SANAD (KSA)
3. KUDZINAU IVAN (WKF-2)
5. ROJAS RODRIGO (CHI)
5. GURBANLI ASIMAN (AZE)
7. BOSTANDZIC ANES (BIH)
7. SAGILYAN EDUARD (USA)

*Seeded

Referees:			

Pool winner-Male Kumite 84+ Kg

Karate World Championships - Individual World Championships - Cairo 2025, 3894+XV8, Al Estad, Qesm Than Madinet Nasr, Cairo Governorate 4436020, EGY

Tatami

Pool

1/1

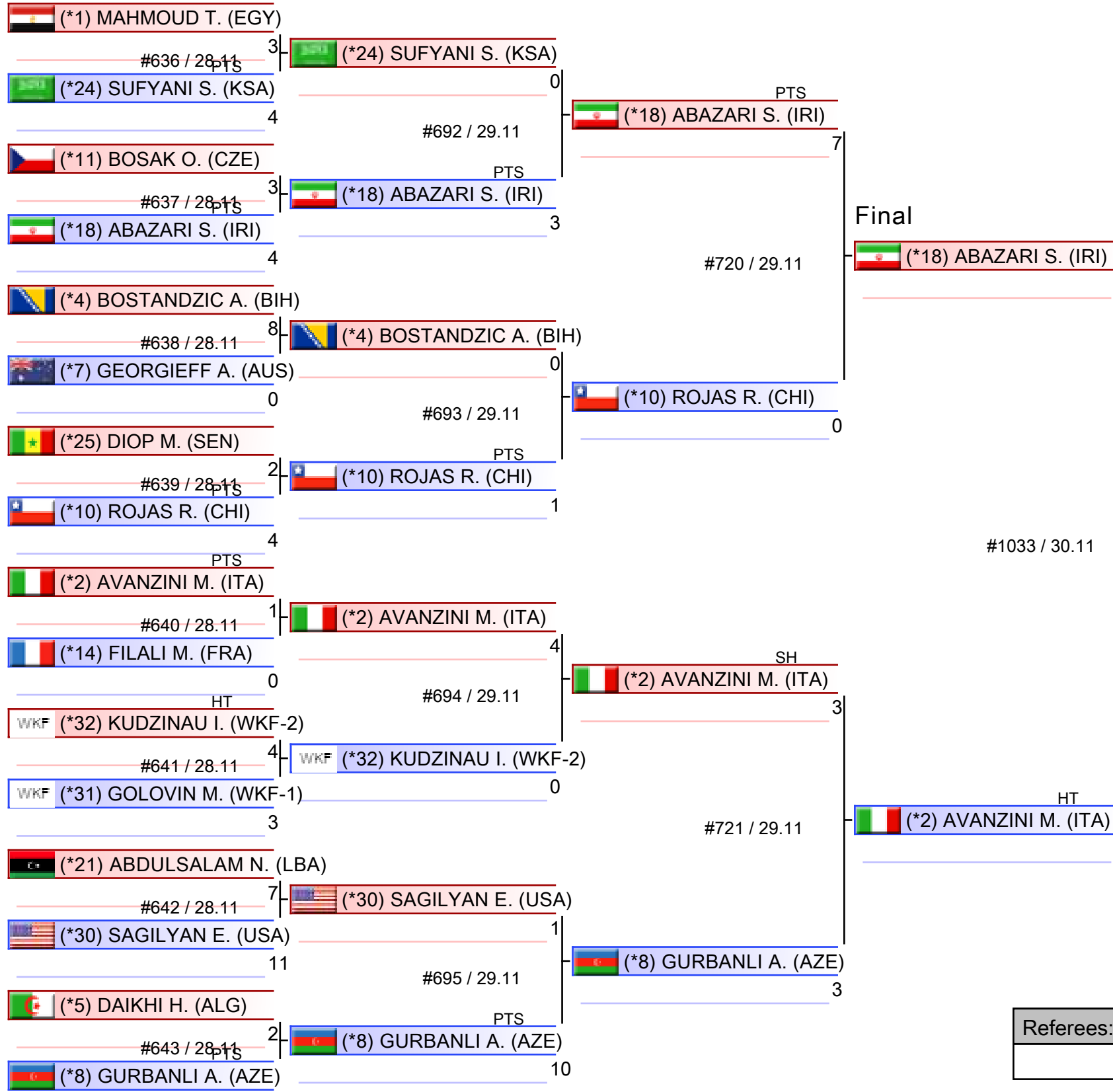

1. AVANZINI MATTEO (ITA)
2. ABAZARI SALEH (IRI)
3. SUFYANI SANAD (KSA)
3. KUDZINAU IVAN (WKF-2)
5. ROJAS RODRIGO (CHI)
5. GURBANLI ASIMAN (AZE)
7. BOSTANDZIC ANES (BIH)
7. SAGILYAN EDUARD (USA)

*Seeded

Referees:			

Male Kumite 84+ Kg

Karate World Championships - Individual World Championships - Cairo 2025

Tatami

Pool
1,2,3,4,5,6,7,8

(c)sportdata GmbH & Co KG 2000-2025 (2025-12-02 21:54) v 11.0.0 build 2 (2025-11-22 17:48 CET) License: SDIL TVG ODF (expire 2026-01-23)

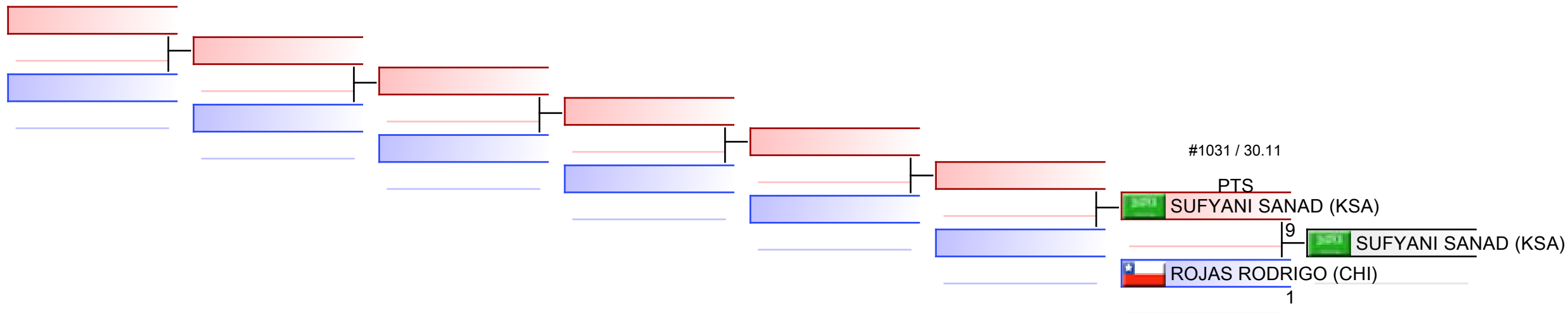

REPECHAGE: (1,2,3,4,5,6,7,8)

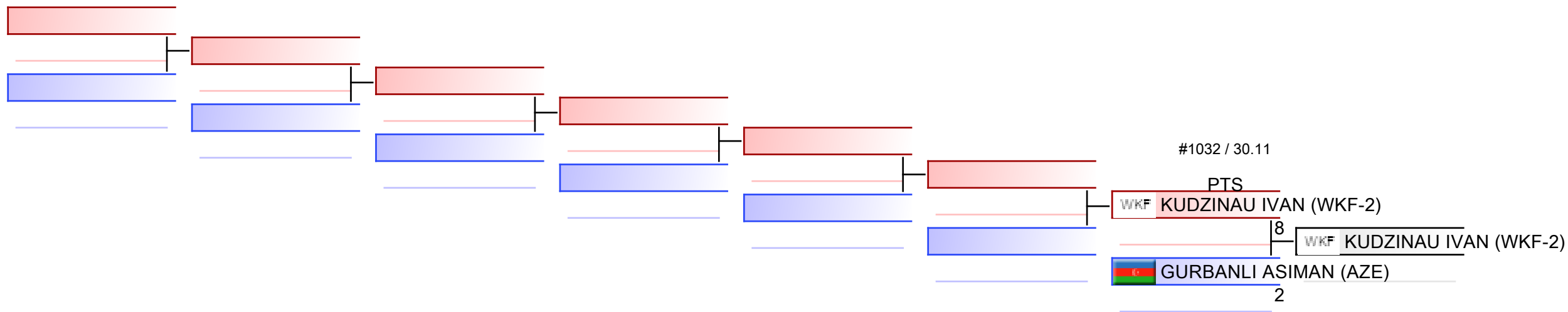

Referees:							
-----------	--	--	--	--	--	--	--



Karate World Championships - Individual World
Championships - Cairo 2025 - 2025-11-27



Official Results

Male Kumite 84+ Kg			
1	AVANZINI MATTEO		ITA - ITALY
2	ABAZARI SALEH		IRI - ISLAMIC REPUBLIC OF IRAN
3	SUFYANI SANAD		KSA - SAUDI ARABIA
3	KUDZINAU IVAN		WKF-2 - WKF-2
5	ROJAS RODRIGO		CHI - CHILE
5	GURBANLI ASIMAN		AZE - AZERBAIJAN
7	BOSTANDZIC ANES		BIH - BOSNIA AND HERZEGOVINA
7	SAGILYAN EDUARD		USA - UNITED STATES

RESULTS BOOK



OFFICIAL RESULTS



Karate World Championships - Individual World
Championships - Cairo 2025 - 2025-11-27



Official Results

Female Kata			
1	LAU MO SHEUNG GRACE		HKG - HONG KONG, CHINA
2	ONO MAHO		JPN - JAPAN
3	D ONOFRIO TERRYANA		ITA - ITALY
3	HESHAM AYA		EGY - EGYPT
5	KOKUMAI SAKURA		USA - UNITED STATES
5	XENOU GEORGIA-ARCHONTIA		GRE - GREECE
7	CRUZ ANA		POR - PORTUGAL
7	MANCA CHIARA		BEL - BELGIUM

Female Kumite -50 Kg			
1	ALIMARDANOVA GULSHAN		UZB - UZBEKISTAN
2	CHANDRAN SHAHMALARANI		MAS - MALAYSIA
3	BAHMANYAR SARA		IRI - ISLAMIC REPUBLIC OF IRAN
3	SALAZAR CAMACHO YORGELIS		VEN - VENEZUELA
5	TSANG YEE TING		HKG - HONG KONG, CHINA
5	ALVARADO LILI		ECU - ECUADOR
7	BONNARDE TIPHAINE		FRA - FRANCE
7	SALAMA REEM AHMED		EGY - EGYPT

Female Kumite -55 Kg			
1	YOUSSEF AHLAM		EGY - EGYPT
2	KVASNICOVA NINA		SVK - SLOVAKIA
3	ABOURICHE LOUIZA		ALG - ALGERIA
3	TERLIUGA ANZHELIKA		UKR - UKRAINE
5	TORO MENESES VALENTINA		CHI - CHILE
5	FURUMOTO-DESHAIES HANA		CAN - CANADA
7	SAADATI FATEME		IRI - ISLAMIC REPUBLIC OF IRAN
7	SADIGOVA MADINA		AZE - AZERBAIJAN

Female Kumite -61 Kg			
1	GOLSHADNEZHAD ATOUSA		IRI - ISLAMIC REPUBLIC OF IRAN
2	GONG LI		CHN - PEOPLES REPUBLIC OF CHINA
3	MAHJOUB Wafa		TUN - TUNISIA
3	KANAY ASSEL		KAZ - KAZAKHSTAN
5	SHOLOHOVA OLEKSANDRA		UKR - UKRAINE
5	AZARAVA MARYIA		WKF-2 - WKF-2
7	OTABOYEVA SEVINCH		UZB - UZBEKISTAN
7	SHIMADA SARARA		JPN - JAPAN

Female Kumite -68 Kg			
1	SOMBE THALYA		FRA - FRANCE
2	FONSECA ROMERO JANESSA MICHELLE		PUR - PUERTO RICO
3	VELOZO ANASTASIIA		CHI - CHILE
3	ZARETSKA IRYNA		AZE - AZERBAIJAN



Karate World Championships - Individual World
Championships - Cairo 2025 - 2025-11-27



Official Results

5	QUIRICI ELENA		SUI - SWITZERLAND	
5	SEMERARO SILVIA		ITA - ITALY	
7	DARENKAYA DAIYANA		KAZ - KAZAKHSTAN	
7	HENDY HADIR		EGY - EGYPT	

Female Kumite 68+ Kg				
1	KNEER JOHANNA		GER - GERMANY	
2	BERULTSEVA SOFYA		KAZ - KAZAKHSTAN	
3	WALTERS ROCHELLE		ENG - ENGLAND	
3	KYDONAKI KYRIAKI		GRE - GREECE	
5	CREEMERS INGRID		NED - NETHERLANDS	
5	QUINTAL CATZIN GUADALUPE		MEX - MEXICO	
7	OKILA MENNA SHAABAN		EGY - EGYPT	
7	BULAY DARIIA		UKR - UKRAINE	

Male Kata				
1	NISHIYAMA KAKERU		JPN - JAPAN	
2	GHINAMI ALESSIO		ITA - ITALY	
3	OZDEMIR ENES		TUR - TURKIYE	
3	TORRES GUTIERREZ ARIEL		USA - UNITED STATES	
5	HRCKA ROMAN		SVK - SLOVAKIA	
5	ELGHOBASHY MOSTAFA		EGY - EGYPT	
7	QUINTERO CAPDEVILA DAMIAN HUGO		ESP - SPAIN	
7	COMANESCU PETRU		ROU - ROMANIA	

Male Kumite -60 Kg				
1	SAMDAN ERAY		TUR - TURKIYE	
2	SELMANI ISLAM		KOS - KOSOVO	
3	HASHIMOTO HIROMU		JPN - JAPAN	
3	XENOS CHRISTOS-STEFANOS		GRE - GREECE	
5	SORDIA TSOTNE		GEO - GEORGIA	
5	TURAKHONOV MEKHRIDDIN		UZB - UZBEKISTAN	
7	AKHMEDOV AKHMED		WKF-1 - WKF-1	
7	MESKINI ALI		IRI - ISLAMIC REPUBLIC OF IRAN	

Male Kumite -67 Kg				
1	GHAITH AFEEF		JOR - JORDAN	
2	OUBAYA SAID		MAR - MOROCCO	
3	AMIRALI DIDAR		KAZ - KAZAKHSTAN	
3	RASHIDOV ABDUL VAKHKHOB		UZB - UZBEKISTAN	
5	FREIRE FUENTES TOMAS		CHI - CHILE	
5	BALLOTIS GEORGIOS		GRE - GREECE	
7	OGANNISIAN IURIK		WKF-1 - WKF-1	
7	HELASSA AYOUB ANIS		ALG - ALGERIA	

Male Kumite -75 Kg				
1	ABDELAZIZ ABDALLA MAMDUH		EGY - EGYPT	



Karate World Championships - Individual World
Championships - Cairo 2025 - 2025-11-27



Official Results

2	ZAPLITNYI ANDRII		UKR - UKRAINE	
3	HARUTYUNYAN SUREN		ARM - ARMENIA	
3	SHARAFUTDINOV ERNEST	WKF	WKF-1 - WKF-1	
5	BERTHON ENZO		FRA - FRANCE	
5	SCOTT THOMAS		USA - UNITED STATES	
7	AZHIKANOV NURKANAT		KAZ - KAZAKHSTAN	
7	SAM HAMZA		MAR - MOROCCO	

Male Kumite -84 Kg

1	BADAWY YOUSSEF		EGY - EGYPT	
2	ARSLAN HASAN		TUR - TURKIYE	
3	ALJAFARI MOHAMMAD		JOR - JORDAN	
3	KVESIC IVAN		CRO - CROATIA	
5	GHAZOUANI RAYEN		TUN - TUNISIA	
5	MARTINA MICHELE		ITA - ITALY	
7	GASPARIAN EDUARD	WKF	WKF-1 - WKF-1	
7	SRITI MEHDI		MAR - MOROCCO	

Male Kumite 84+ Kg

1	AVANZINI MATTEO		ITA - ITALY	
2	ABAZARI SALEH		IRI - ISLAMIC REPUBLIC OF IRAN	
3	SUFYANI SANAD		KSA - SAUDI ARABIA	
3	KUDZINAU IVAN	WKF	WKF-2 - WKF-2	
5	ROJAS RODRIGO		CHI - CHILE	
5	GURBANLI ASIMAN		AZE - AZERBAIJAN	
7	BOSTANDZIC ANES		BIH - BOSNIA AND HERZEGOVINA	
7	SAGILYAN EDUARD		USA - UNITED STATES	

MEDAL STANDING



Karate World Championships - Individual World
Championships - Cairo 2025 - 2025-11-27



Medals - National Federation

Rank	National Federation	1. Place	2. Place	3. Place
1	EGYPT, EGY	3	0	1
2	ITALY, ITA	1	1	1
	JAPAN, JPN	1	1	1
	ISLAMIC REPUBLIC OF IRAN, IRI	1	1	1
	TURKIYE, TUR	1	1	1
6	UZBEKISTAN, UZB	1	0	1
	JORDAN, JOR	1	0	1
8	GERMANY, GER	1	0	0
	HONG KONG, CHINA, HKG	1	0	0
	FRANCE, FRA	1	0	0
11	KAZAKHSTAN, KAZ	0	1	2
12	UKRAINE, UKR	0	1	1
13	PUERTO RICO, PUR	0	1	0
	PEOPLES REPUBLIC OF CHINA, CHN	0	1	0
	SLOVAKIA, SVK	0	1	0
	KOSOVO, KOS	0	1	0
	MALAYSIA, MAS	0	1	0
	MOROCCO, MAR	0	1	0
19	GREECE, GRE	0	0	2
20	ENGLAND, ENG	0	0	1
	ALGERIA, ALG	0	0	1
	TUNISIA, TUN	0	0	1
	UNITED STATES, USA	0	0	1
	CHILE, CHI	0	0	1
	AZERBAIJAN, AZE	0	0	1
	VENEZUELA, VEN	0	0	1
	ARMENIA, ARM	0	0	1
	WKF-1, WKF-1	0	0	1
	CROATIA, CRO	0	0	1
	SAUDI ARABIA, KSA	0	0	1
	WKF-2, WKF-2	0	0	1